

Model #

1151GBCHd

Cascade

6-Drawer Chest

Glazed Black Cherry finish

Assembly Instructions

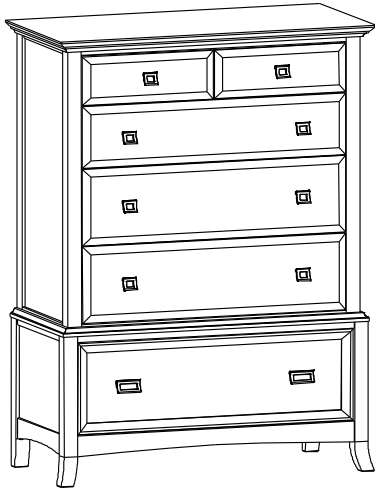

Congratulations!

This fine piece of furniture will make a gorgeous addition to your home. For the best results, read the Assembly Instructions before you begin your project.

IMPORTANT NOTES:

- For normal household use only. *Not* recommended to use this product in a commercial setting.
- Do not climb, sit or stand on or in this piece of furniture.
- Do not overload the drawers.
- Unload items before you move this unit.
- Before you load or move this unit, tighten all screws and supports.
- Before you begin your project, completely read the Assembly Instructions.
- Store this item: 1- in its box; 2- in a dry place; 3- in temperatures that range from 40°F to 90°F (not on a cold and possibly damp cement floor).
- Periodically inspect your furniture for any loose glue joints, screws or any other problem that might affect the stability of your furniture. Tighten or repair as needed.
- This assembly requires two people.

WARNING

Serious or fatal crushing injuries can occur from furniture tip-over. Use of tip-over restraints may only reduce but not eliminate the risk of tip-over.

To help prevent tip-over:

- Place heaviest items in the bottom drawers.
- Unless specifically designed to accommodate, do not set TVs or other heavy objects on top of this product.
- Never allow children to climb or hang on drawers, doors or shelves.
- Never open more than one drawer at a time.

Warning: At least one tipping restraint kit was included with your piece of Whittier Wood Furniture. When you receive your furniture, be sure to find and properly install the tipping restraint(s). If you cannot locate the restraint(s), please contact us immediately for replacement.

Notice to California Customers

California Prop 65 requires consumer goods to be labeled if any one of 850+ different chemicals or substances, including wood dust, is present even in trace amounts. Drilling, sawing, sanding or machining wood products generates wood dust, a substance known to the State of California to cause cancer. **Warning:** This product contains a chemical or substance known to the State of California to cause cancer, birth defects or other reproductive harm. *California Health and Safety Code Section 25249.6*

DESIGN SUBJECT TO CHANGE WITHOUT NOTICE.

CALL US FIRST! *Do not return this item to the store*

Service Policy: We will replace any part that is defective, missing or damaged during assembly. For a replacement part, directly contact Whittier Wood Products customer service department by phone, fax, mail or email.

Hours: Our friendly customer service staff can be reached Monday-Friday 7:00 a.m. to 5:00 p.m. (Pacific Time). You may leave a message 24 hours a day, seven days a week.

To Order: Provide the finish and furniture model number (upper portion of this page), the part letter, production code, quantity needed, reason for replacement and your full name, address and telephone number.

Parts ship from our Eugene, Oregon factory within one or two business days from the time we receive your request. Please allow five to ten business days for delivery.

800-653-3336 • Outside the U.S. or Canada: 541-687-0213 • Fax: 541-687-2060
www.whittierwood.com • P.O. Box 2827 • Eugene, Oregon 97402, U.S.A.



P.O. Box 2827
Eugene, OR 97402 USA

Production Code:























VN

06/14

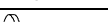
1151GBCHd Cascade 6-Drawer Chest

Parts List

Please identify the parts and check that quantities received match those on this list.
If you need to replace a part, refer to the following letter(s) and part name.

Part	Description		Quantity
A	Top Assembly (attached)		1
Ba	Case		1
C	Small Upper Drawer Box (inserted)		2
D	Medium Upper Drawer Box (inserted)		1
E	Large Upper Drawer Box (inserted)		2
F	Bottom Drawer Box (inserted)		1
G	Small Upper Drawer Face (installed)		2
H	Medium Upper Drawer Face (installed)		1
I	Large Upper Drawer Face (installed)		2
J	Bottom Drawer Face (installed)		1
K	Small Pull (attached)		8
Ld	#8 x 1-1/2" Machine Screw Tuscan (installed)		16
M	Large Pull (attached)		2
Nd	#8 x 1-1/4" Machine Screw Tuscan (installed)		4
O	Drawer Slides (pre-installed sets)		6
P	#6 x 1/2" Philtruss Screw (inserted)		36
Q	#6 x 3/4" Philtruss Screw (inserted)		36
Rd	#8 x 7/8" Black Lo-Profile Screw (inserted)		40
T	Small Adjustable Glide (installed)		4
U	#8 x 1-1/4" Pan Head Screw (inserted)		24
W	#8 x 1-5/8" Black Screw (inserted)		2
X	Insert Nut (inserted)		4
Y	#8 x 1-3/8" Lo-Profile Screw (inserted)		8
TS	Furniture Tipping Restraint (attached)		1 set

1151GBCHd Cascade 6-Drawer Chest

Assembly Instructions

Tool Required: Phillips Screwdriver, Pencil.

1. Place the chest at its final destination. Rotate the Adjustable Glides (T) on the bottoms of the legs until the unit is level. See Figure 1.



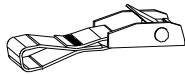
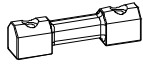



Fig. 1

Continued on Page 4

1151GBCHd Cascade 6-Drawer Chest
Assembly Instructions

Furniture Tipping Restraint Instructions

Before you begin this assembly, identify each part and make sure the quantities received match what is on this list. If you need to replace a part, contact Whittier Wood Furniture customer service and refer to the following list for its name and letter code.

Part	Description		Quantity
A	Cam Buckle and Short Strap (installed)		1
B	Plastic Bracket (installed)		1
C	1" x 1000mm Long Strap (installed)		1
D	#8 x 3" Pan Head Screw		2
E	#10 x 1" Oval Head Screw (inserted)		1
F	Washer		1

If you have a stone or tile floor or do not wish to drive screws into the corner of the baseboard and floor see the instruction included inside the tipping restraint kit for an alternate installation.

- Decide where you want to place the piece of furniture in your room. Mark the baseboard with a pencil mark directly behind the location where the tipping restraint is attached to your item. Move the item away from the wall far enough to allow you to access the spot where the baseboard meets the floor. Position the straps and Plastic Bracket (B) as shown in Figures 2 and 2a with the angled corners of the Plastic Bracket (B) firmly placed against the seam of the baseboard and floor. Attach by driving #8 x 3" Pan Head Screws (D) through the holes in the Plastic Bracket (B) into the seam below the baseboard where it meets the floor. See Figures 2 and 2a.

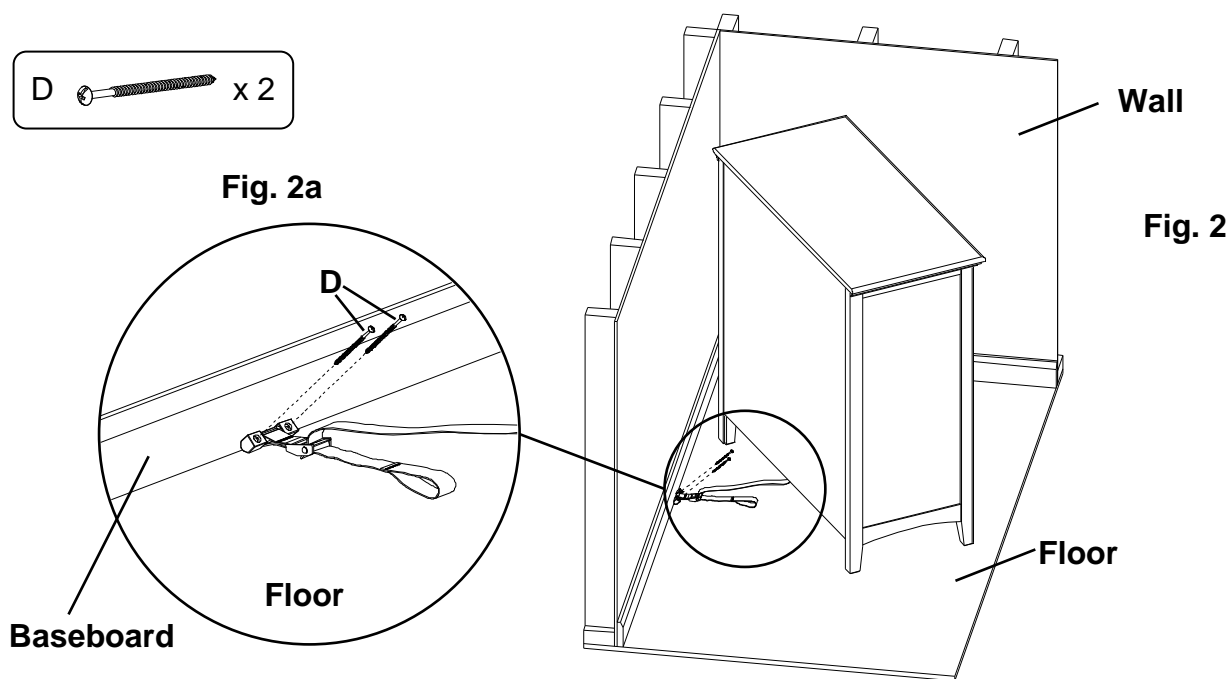

1151GBCHd Cascade 6-Drawer Chest

Assembly Instructions

3. Move the item back into position against the wall and reach underneath the piece of furniture to grasp the loop in the free end of the strap. Pull the free end of the strap until portion between the Cam Buckle (A) and the back apron of the item is tight. See Figures 3 and 3a. If you need to move the piece of furniture reach beneath and locate the buckle which connects the two sections of the strap and depress the release lever, then pull on the section of strap that is between the buckle and the back apron of the furniture until there is enough slack to allow you to pull the item away from the wall.

