

Model #

1361GACf

1361CAff

McKenzie Twin Bookcase

Headboard

GAC = Glazed Antique Cherry finish

CAF = Caffè finish

Assembly Instructions

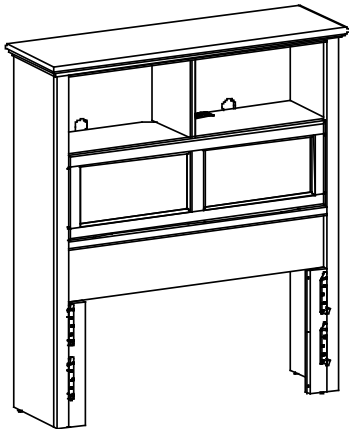

Thank you for allowing us to help you furnish your home. We are certain you will be delighted with your new furniture for many years to come.

IMPORTANT NOTES:

- For normal household use only. *Not* recommended for commercial use.
- Unload items before you move this unit.
- Do not overload the concealed storage areas.
- Do not overload the cubbies.
- This assembly requires two people.

WARNING

Drilling, sawing, sanding or machining wood products can expose you to wood dust, a substance known to the state of California to cause cancer. Avoid inhaling wood dust or use a dust mask or other safeguards for personal protection.

For more information go to: www.p65warnings.ca.gov/wood

This product can expose you to chemicals, including formaldehyde, which are known to the State of California to cause cancer.

For more information go to: www.p65warnings.ca.gov/furniture

DESIGN SUBJECT TO CHANGE WITHOUT NOTICE.

CUSTOMER SERVICE

If you ever have questions about your furniture, please do not hesitate to contact us. In the unlikely event you need a replacement part; we can make those parts available through an authorized Whittier Wood Furniture dealer. If you cannot order replacement parts through your dealer, please contact our customer service department.

Hours: Our friendly customer service staff can be reached:

Monday-Friday 8:00 a.m. to 5:00 p.m. (Pacific Time).

You may leave a message 24 hours a day, seven days a week.

Customer Service: 800-653-3336 • **Outside the U.S.:** 541-687-0213

Fax: 541-687-2060 • **Email:** info@whittierwood.com

**Whittier
Wood**
FURNITURE

P.O. Box 2827
Eugene, OR 97402 USA

Production Code:













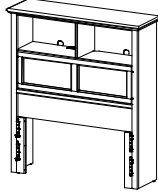

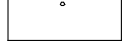
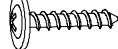

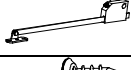



VN

08/17

1361GACf 1361CAFf McKenzie Twin Bookcase Headboard

Parts List

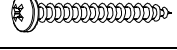
Please identify the parts and check that quantities received match those on this list.
If you need to replace a part, refer to the following letter and part name.

Part	Description		Quantity
B	Left Bracket (attached)		2
C	Right Bracket (attached)		2
D	#8 x 1" Black Screw (inserted)		16
Ed	Bookcase Headboard Assembly		1
F	Assembled Door (attached)		1
G	False Bottom		2
le	#8 x 7/8" Black Lo-Profile Screw (inserted)		4
J	Wire Clip Screw (attached)		3
K	Door Stay (attached)		1
L	#6 x 5/8" Undercut Screw ZN (inserted)		4
M	Door Stay Support (attached)		1
N	#6 x 1-1/4" Black Pan Head Screw (inserted)		3
O	Hinge (installed)		3
P	#6 x 5/8" Undercut Screw AB (inserted)		22
Q	Magnetic Catch Kit (attached)		2 sets
R	#6 x 5/8" Philtruss Screw (inserted)		9
S	Corner Brace (attached)		2
T	Large Adjustable Glide (installed)		2
U	#8 x 5/8" Pan Head Screw (inserted)		8
V	#8 x 1-1/4" Black Screw (inserted)		4
W	#8 x 2-1/4" Black Screw (inserted)		6
X	#8 x 1-1/4" Pan Head Screw (inserted)		4
XA	Top Assembly (attached)		1
XB	Power Bar and USB (installed)		1

1361GACf 1361CAFf McKenzie Twin Bookcase Headboard
Parts List

YA	Tack Glide (attached)		4
ZE	#14 x 1-1/4" Pan Head Screw		6
ZF	Washer		6
ZI	#8 x 1-3/8" Lo-Profile Screw (inserted)		6

1361GACf 1361CAFf McKenzie Twin Bookcase Headboard

Assembly Instructions

Tools Required: Drill, 1/8" bit, Phillips screwdriver, Slotted screwdriver

NOTE: Use this instruction and hardware kit included with this 1361 McKenzie Twin Bookcase Headboard **ONLY** if you are using a Hollywood frame.

IF you are using this product with Whittier Wood Furniture Footboard and Pedestal kits, disregard this instruction and hardware and use what is included with your Footboard kit.

1. Remove the metal brackets attached to the Headboard (Ed).
2. Adjust the Hollywood frame to fit your mattress and box spring.
3. Place the Headboard (Ed) against the end brackets of the frame and mark the locations for the screws. Drill pilot holes approximately 1-1/4" deep. To make sure you don't drill deeper, measure 1-1/4" up from the end of the drill bit and wrap a piece of tape around the bit. Stop drilling when the edge of the tape meets the wood.
4. Position the Headboard (Ed) against the frame and attach using six #14 x 1-1/4" Pan Head Screws (ZE) and six Washers (ZF).
5. Place your bed in its final position. To level the headboard, reach behind the bookcase front legs and, using a slotted screwdriver, find the Large Adjustable Glide (T). Using a slotted screw driver, rotate the Large Adjustable Glides (T) clockwise until they bear weight. See Figures 5, 5a and 5b.

This is important if the bookcase headboard sits upon a carpet tack strip.

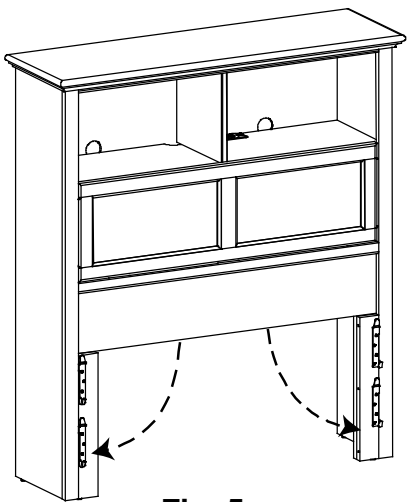

Fig. 5

Hollywood bed frame removed for illustration purposes.

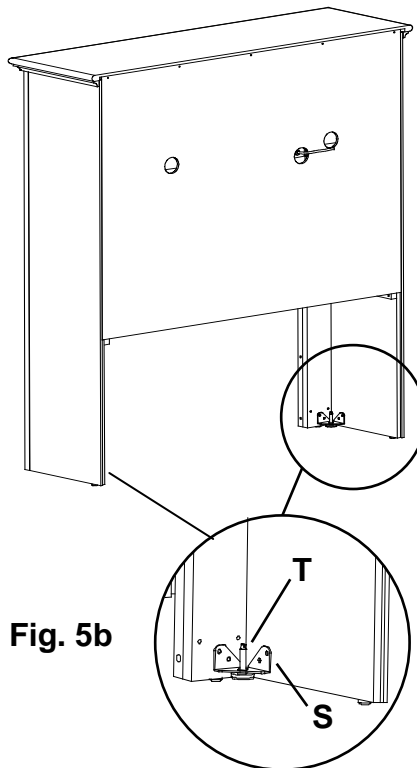

Fig. 5a

Fig. 5b

The top of the Large Adjustable Glide (T) is slotted.

1361GACf 1361CAFf McKenzie Twin Bookcase Headboard

Assembly Instructions

6. To adjust the brake tension on the Door Stay (K) turn the screw on the Door Stay clockwise to loosen or counterclockwise to tighten. See Figures 6 and 6a.



Fig. 6a

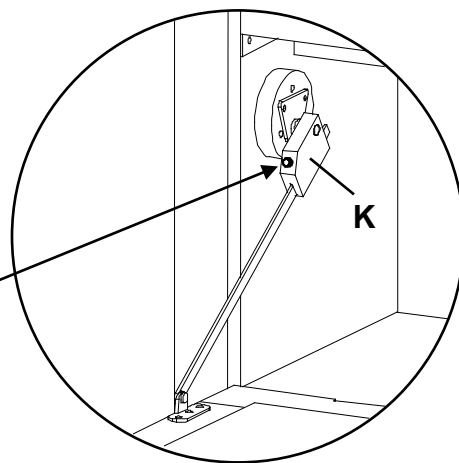

Fig. 6

7. Unwrap the False Bottoms (G) and place them on top of the rails in the Headboard Assembly (Ed). Make sure the finger holes face forward as shown in Figure 7. After you have placed your electronics inside the cubbies, use the Wire Clips (J) on the underside of the cubbies to secure the wires. Close the door tightly making sure the magnetic catches and plates securely touch.

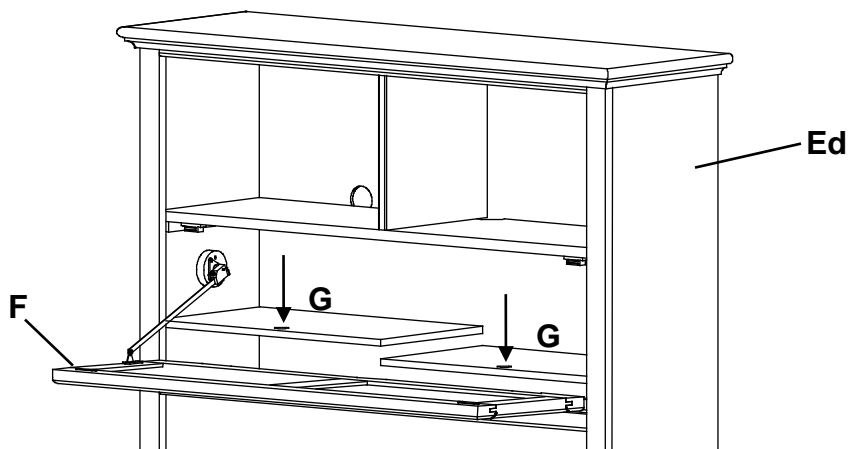

Fig. 7