

Model #

1370AUF1

McKenzie Queen Bookcase Storage Bed

Assembly Instructions

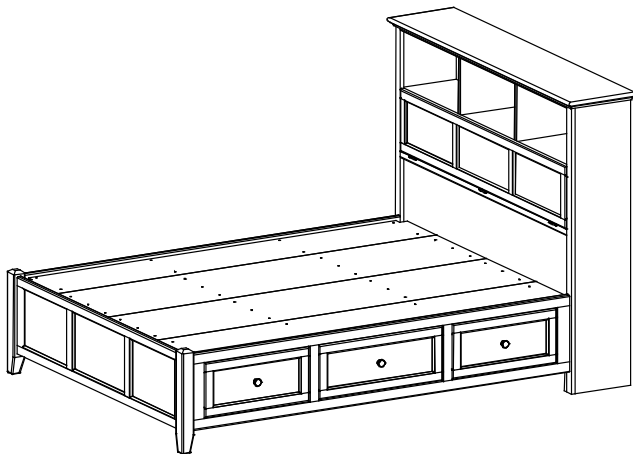

Thank you for allowing us to help you furnish your home. We are certain you will be delighted with your new furniture for many years to come.

IMPORTANT NOTES:

- For normal household use only. *Not* recommended for commercial use.
- Unload items before you move this unit.
- Do not overload the concealed storage areas.
- Do not overload the drawers.
- Before you begin your project, completely read the Assembly Instructions and Finishing Hints.
- This assembly requires two people.

WARNING

Drilling, sawing, sanding or machining wood products can expose you to wood dust, a substance known to the state of California to cause cancer. Avoid inhaling wood dust or use a dust mask or other safeguards for personal protection.

For more information go to: www.p65warnings.ca.gov/wood

This product can expose you to chemicals, including formaldehyde, which are known to the State of California to cause cancer.

For more information go to: www.p65warnings.ca.gov/furniture

DESIGN SUBJECT TO CHANGE WITHOUT NOTICE.

CUSTOMER SERVICE

If you ever have questions about your furniture, please do not hesitate to contact us. In the unlikely event you need a replacement part; we can make those parts available through an authorized Whittier Wood Furniture dealer. If you cannot order replacement parts through your dealer, please contact our customer service department.

Hours: Our friendly customer service staff can be reached:

Monday-Friday 8:00 a.m. to 5:00 p.m. (Pacific Time).

You may leave a message 24 hours a day, seven days a week.

Customer Service: 800-653-3336 • **Outside the U.S.:** 541-687-0213

Fax: 541-687-2060 • **Email:** info@whittierwood.com

**Whittier
Wood**
FURNITURE

P.O. Box 2827
Eugene, OR 97402 USA

Production Code:

VN











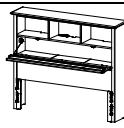

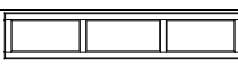
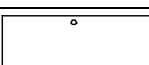
09/17

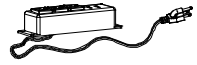
1370AUF1 McKenzie Queen Bookcase Storage Bed

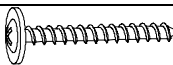
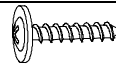
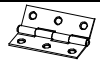

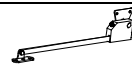

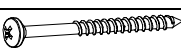
Parts List

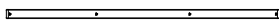
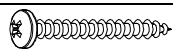
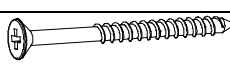
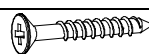
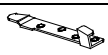
Please identify the parts and check that quantities received match those on this list.
If you need to replace a part, refer to the following letter and part name.

1372AUF1 Headboard Kit (x1)











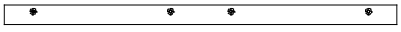

Part	Description	Quantity
Aj	Headboard Assembly 	1
E	#8 x 1-1/4" Black Screw (inserted) 	8
Rc	Assembled Door (attached) 	1
Sd	False Bottom 	3
XA	Top Assembly (attached) 	1
XB	Power Bar and USB (installed) 	1
YA	Large Adjustable Glide (installed) 	2
YB	#8 x 5/8" Pan Head Screw (inserted) 	8
YJ	#8 x 1-3/8" Lo-Profile Screw (inserted) 	8
YL	#8 x 7/8" Black Lo-Profile Screw (inserted) 	4
ZA	Hinge (installed) 	3
ZB	Magnetic Plate (installed) 	2
ZC	Magnetic Catch (installed) 	2
ZE	Door Stay (attached) 	1
ZF	#6 x 5/8" Undercut Screw ZN (inserted) 	4
ZG	Door Stay Support (attached) 	1
ZH	#6 x 1-1/4" Black Pan Head Screw (inserted) 	3
ZI	#6 x 5/8" Undercut Screw AB (inserted) 	22
ZJ	#6 x 5/8" Philtruss Screw (inserted) 	12
ZM	Door Cleat (attached) 	1
ZN	#8 x 1-1/4" Pan Head Screw (inserted) 	9
ZO	#8 x 2-1/4" Black Screw (inserted) 	6
ZP	#8 x 1" Black Screw (inserted) 	16
ZQ	Left Bracket (attached) 	2

1370AUF1 McKenzie Queen Bookcase Storage Bed
Parts List

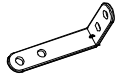
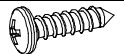
Part	Description		Quantity
ZR	Right Bracket (attached)		2
ZS	Wire Clip Screw (attached)		6
ZT	Tack Glide (attached)		4
ZZ	Corner Brace (attached)		2

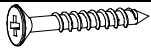
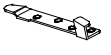
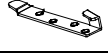

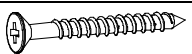









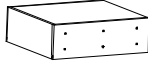

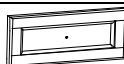
1370AUF1 McKenzie Queen Bookcase Storage Bed
Parts List

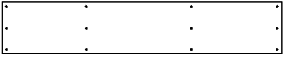
1373AUF1 Footboard Kit (x1)

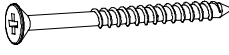
Part	Description		Quantity
Be	Footboard Assembly		1
De	Trestle With T-Nuts		7
E	#8 x 1-1/4" Black Screw		33 (9 inserted)
F	1/4" x 1-3/4" Hex Bolt		26
Ue	Assembled Foot		3
W	Adjustable Glide (installed)		3
YD	#6 x 1/2" Philtruss Screw		8
YH	90° Bracket		2
YM	#10 x 3/4" Pan Head Screw (inserted)		12
ZK	18mm Washer		26
ZP	#8 x 1" Black Screw (inserted)		16
ZQ	Left Bracket (attached)		2
ZR	Right Bracket (attached)		2
ZU	1/4" T-Nut (inserted)		28
ZX	#8 x 1-5/8" Black Screw (inserted)		4
ZY	Foot Bracket (attached)		3

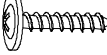
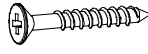
1370AUF1 McKenzie Queen Bookcase Storage Bed
Parts List

1318AUFe Pedestal Kit (x2)

Part	Description	Quantity
E	#8 x 1-1/4" Black Screw (inserted) 	30
Id	Pedestal Kit 	1
J	Small Drawer Box (assembled) 	2
Kd	Large Drawer Box (assembled) 	1
L	Small Drawer Face (attached) 	2
Md	Large Drawer Face (attached) 	1
Ne	#8 x 1-1/2" Machine Screw Tuscan (installed) 	3
O	Knob (attached) 	3
Pd	Deckboard 	1
Q	20" Drawer Slides (installed) 	3 sets
T	#8 x 2" Black Screw (inserted) 	12
YD	#6 x 1/2" Philtruss Screw (inserted) 	18
YE	#6 x 3/4" Philtruss Screw (inserted) 	18
YL	#8 x 7/8" Black Lo-Profile Screw (inserted) 	20
ZP	#8 x 1" Black Screw (inserted) 	16
ZQ	Left Bracket (attached) 	2
ZR	Right Bracket (attached) 	2
ZX	#8 x 1-5/8" Black Screw (inserted) 	16

1370AUF1 McKenzie Queen Bookcase Storage Bed

Assembly Instructions

This assembly requires two people.

Tools Required: Phillips screwdriver, Slotted screwdriver, 7/16" open end or box end wrench and Tape measure.

1. Remove the Trestles (De) and Assembled Feet (Ue) from the backs of the Footboard (Be) and place them off to the side. See Figures 1 and 1a.

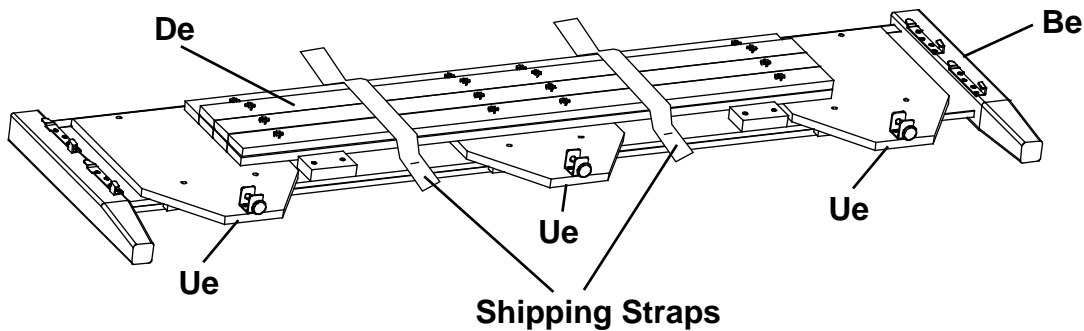

Fig. 1

2. Place both Pedestals (Id) approximately 63" apart as shown in Figure 2.

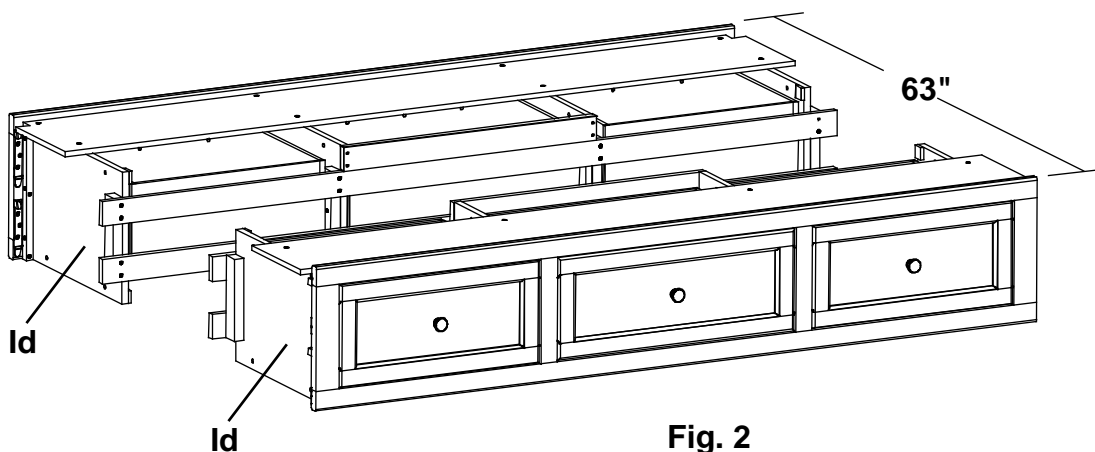

Fig. 2

1370AUF1 McKenzie Queen Bookcase Storage Bed

Assembly Instructions

This assembly requires two people.

- To attach the Footboard (Be) to the Pedestal Assembly (Id), align the Brackets and slide the Pedestal Assembly down on to the Footboard (Be). See Figures 3 and 3a.

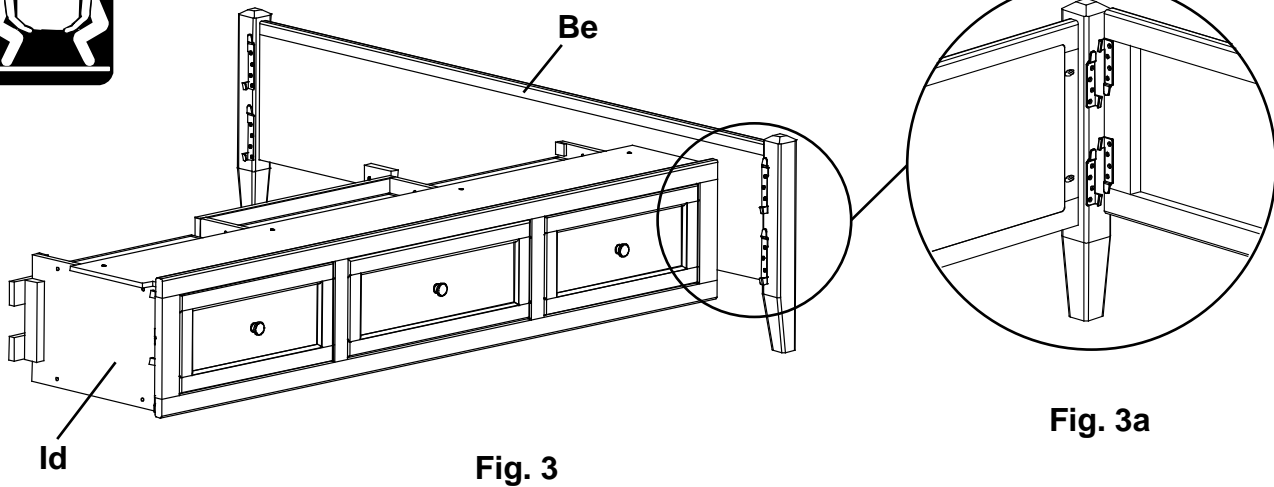

- Repeat step three for the left side.

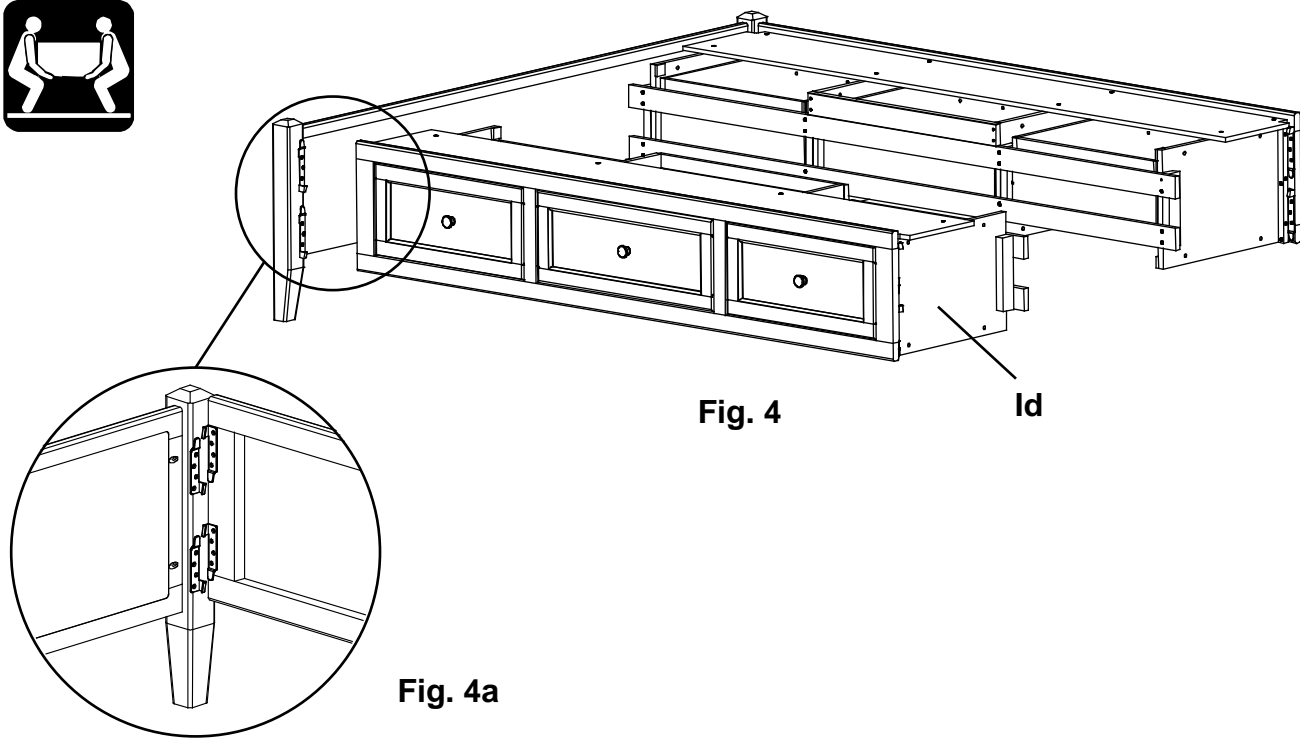

1370AUF1 McKenzie Queen Bookcase Storage Bed

Assembly Instructions

This assembly requires two people.

5. Align the Brackets on both sides and slide the Pedestal/Footboard assembly down on to the Headboard (Aj). See Figure 5.

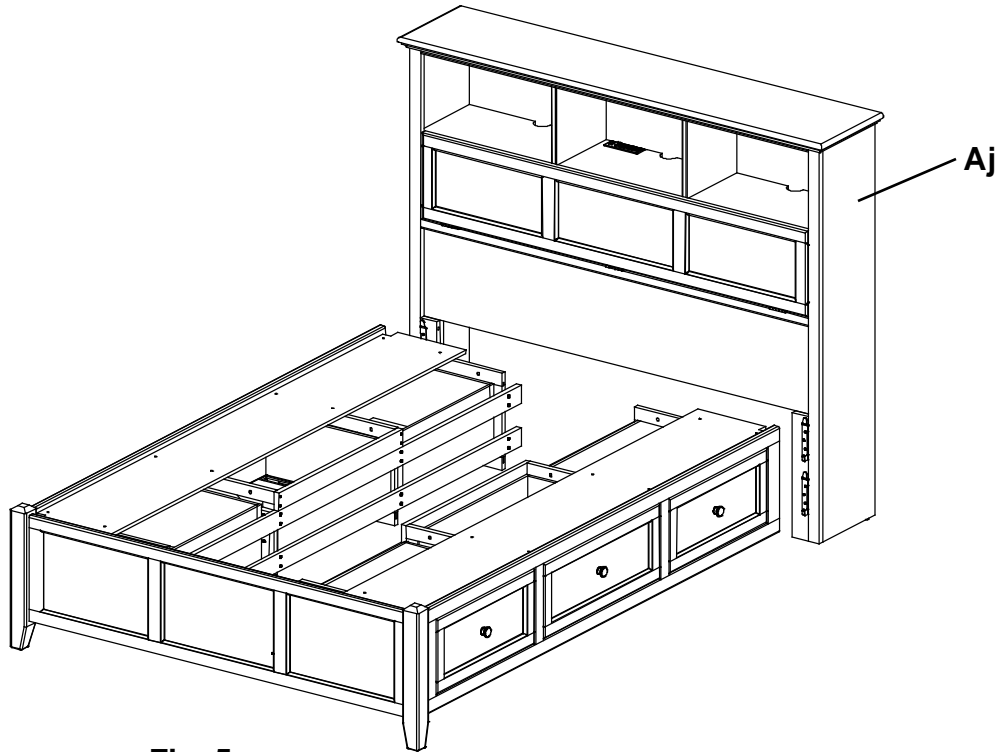

Fig. 5

1370AUF1 McKenzie Queen Bookcase Storage Bed

Assembly Instructions

This assembly requires two people.

6. Open the drawers. Face the Footboard and stand in between the first and second braces. Place a Trestle with T-Nuts (De) on the outside surfaces of the first upper left and right braces so that the T-Nuts (ZU) sit near the top. See Figure 6a. Line up the upper edges of the trestle and braces so they are nearly flush. Insert two 1/4" x 1-3/4" Hex Bolts (F) and Washers (ZK) and tighten. Repeat for the second upper brace.

Place a Trestle with T-Nuts (De) on the outside surface of the second lower brace so that the T-Nuts (ZU) sit near the bottom. Line up the bottom edges of the trestle and braces so they are nearly flush. Insert two 1/4" x 1-3/4" Hex Bolts (F) and Washers (ZK) and tighten. See Figures 6 and 6a.

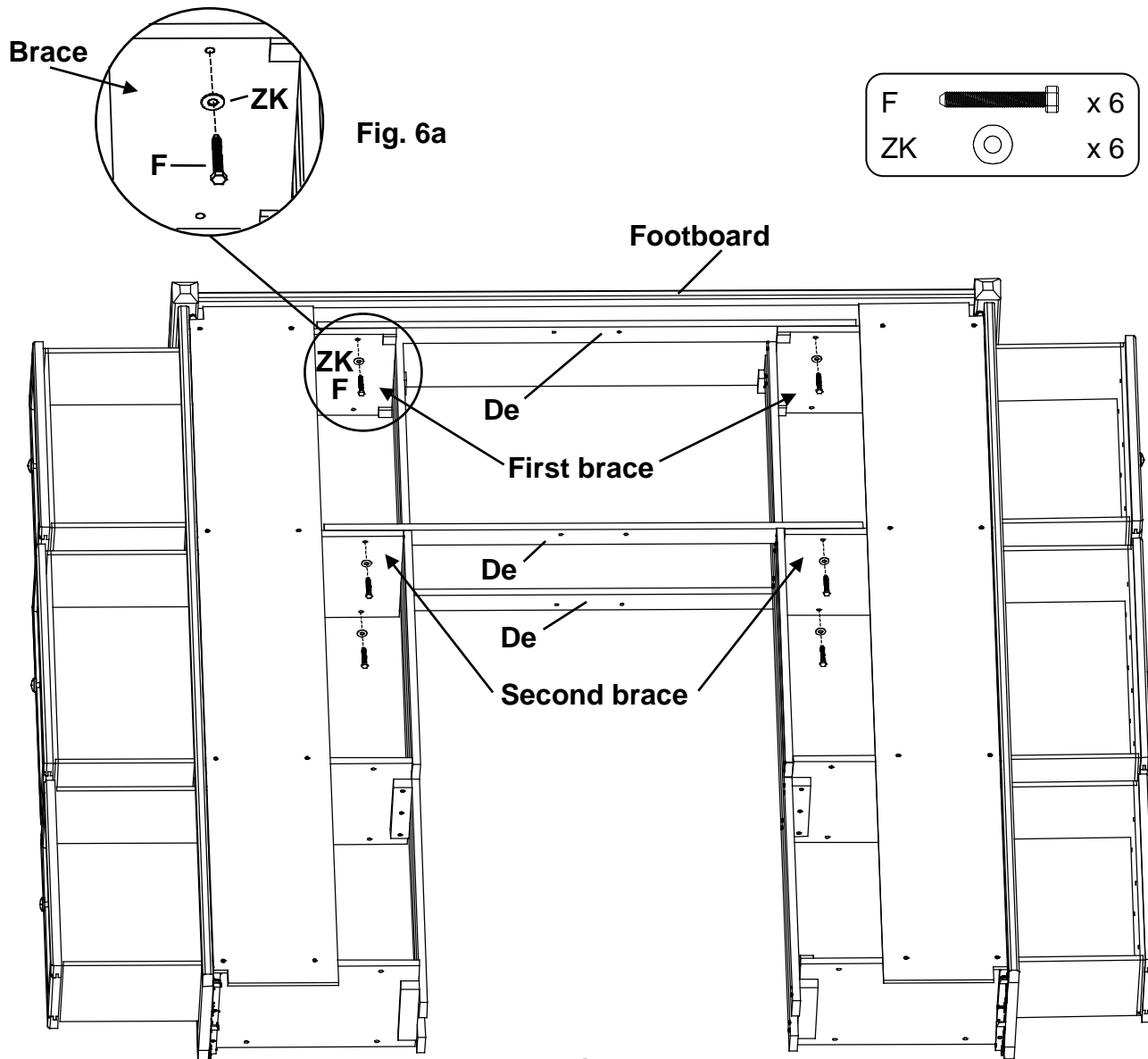

Fig. 6

Headboard removed for illustration purposes.

1370AUF1 McKenzie Queen Bookcase Storage Bed

Assembly Instructions

This assembly requires two people.

7. Face the Headboard and stand in between the third and fourth braces. Place a Trestle with T-Nuts (De) on the outside surfaces of the third **upper** left and right braces so the T-nuts sit near the top. See Figures 7 and 7a. Line up the upper edges of the trestle and braces so they are nearly flush. Insert two 1/4" x 1-3/4" Hex Bolts (F) and Washers (ZK) and tighten.

Place a Trestle with T-Nuts on the outside surface of the third left and right **lower** braces so that the T-nuts sit near the bottom. Line up the bottom edges of the trestle and braces so they are nearly flush. Insert two 1/4" x 1-3/4" Hex Bolts (F) and Washers (ZK) and tighten. See Figures 7 and 7a.

Repeat for the fourth braces.

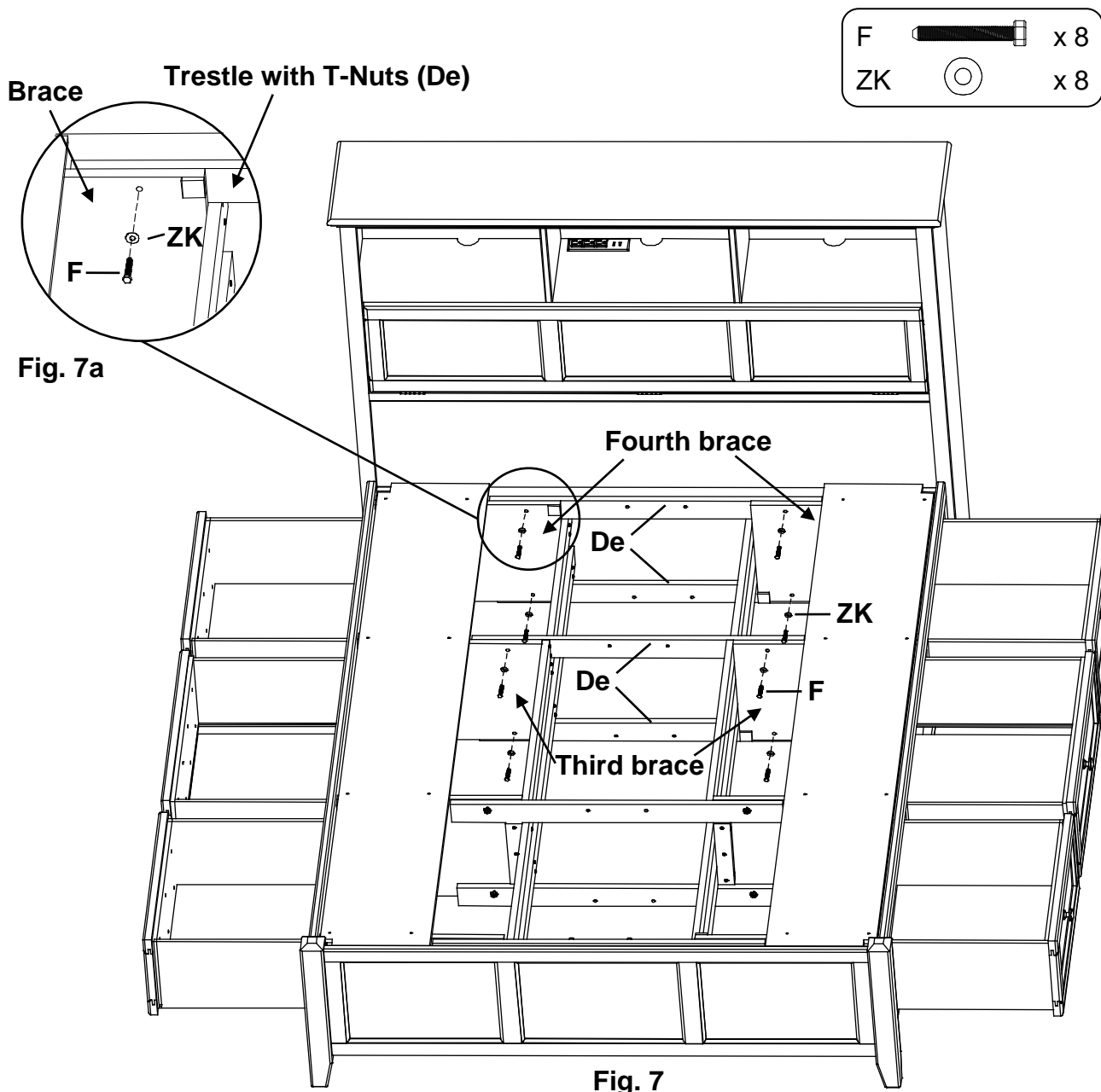

1370AUF1 McKenzie Queen Bookcase Storage Bed

Assembly Instructions

This assembly requires two people.

8. **NOTE:** There are blocks mounted on the back side of the Footboard to support the end of the pedestal eliminating the need for an Assembled Foot in this position where it would be easily visible. Do not attach an Assembled Foot in the position near the footboard.

Facing the Headboard, place two Assembled Feet (Ue) on the inside faces of the third and fourth upper and lower Trestles. Attach with Washers (ZK) and 1/4" x 1-3/4" Hex Bolts (F). See Figures 8 and 8a.

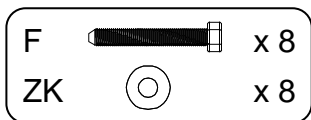

Trestle with T-Nuts (De)

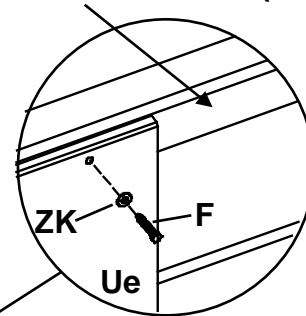

Fig. 8a

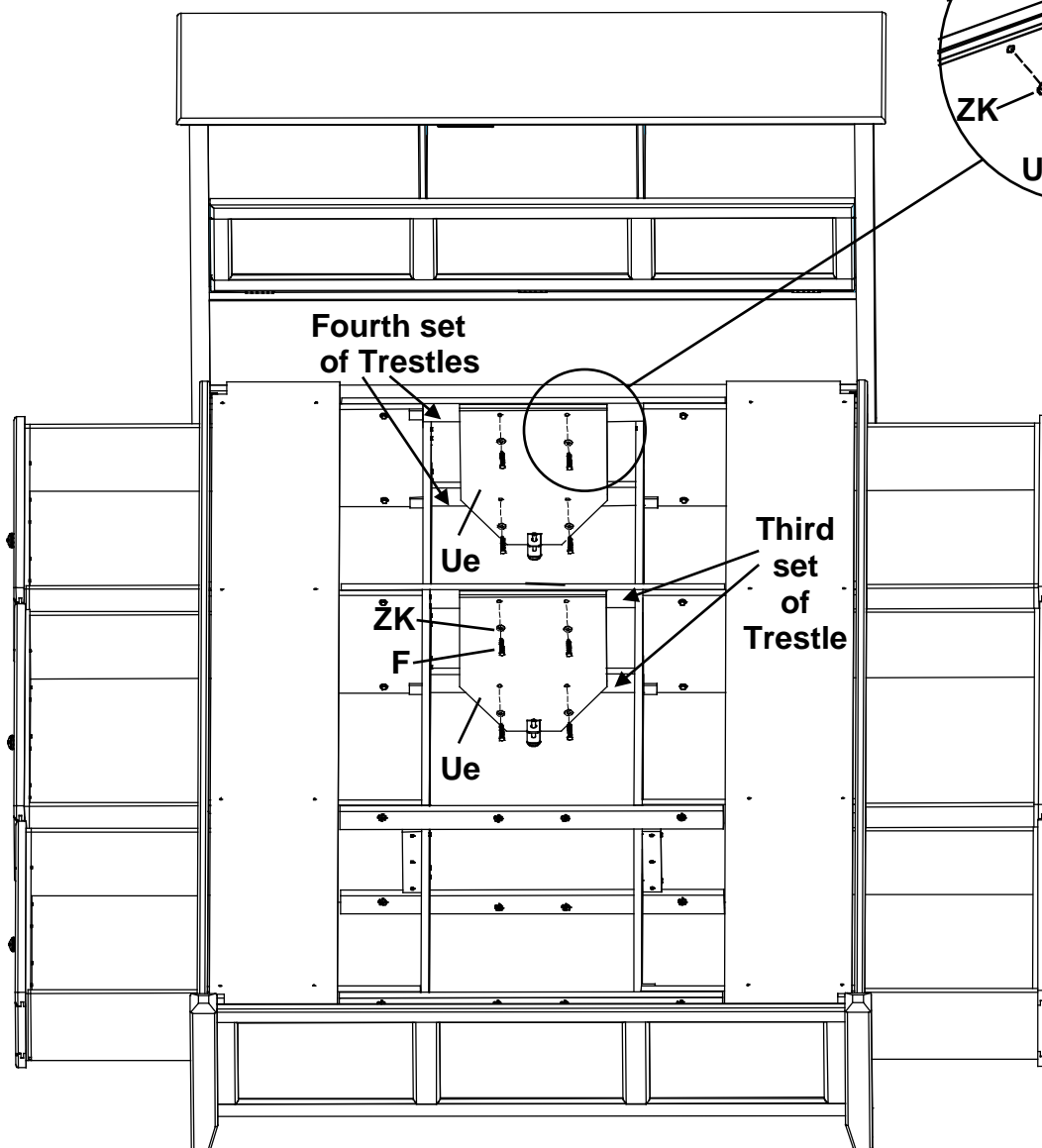

Fig. 8

1370AUF1 McKenzie Queen Bookcase Storage Bed

Assembly Instructions

This assembly requires two people.

9. **NOTE:** There are blocks mounted on the back side of the Footboard to support the end of the pedestal eliminating the need for an Assembled Foot in this position where it would be easily visible. Do not attach an Assembled Foot in the position near the footboard.

Facing the Footboard, place an Assembled Foot (Ue) on the inside of the second set of Trestles and attach with four Washers (ZK) and four 1/4" x 1-3/4" Hex Bolts (F). See Figures 9 and 9a.

Adjust all three Glides (W) found at the bottoms of the Assembled Feet so that the Glides just touch the floor.

IMPORTANT: Make sure the Glides touch the floor and carry weight.

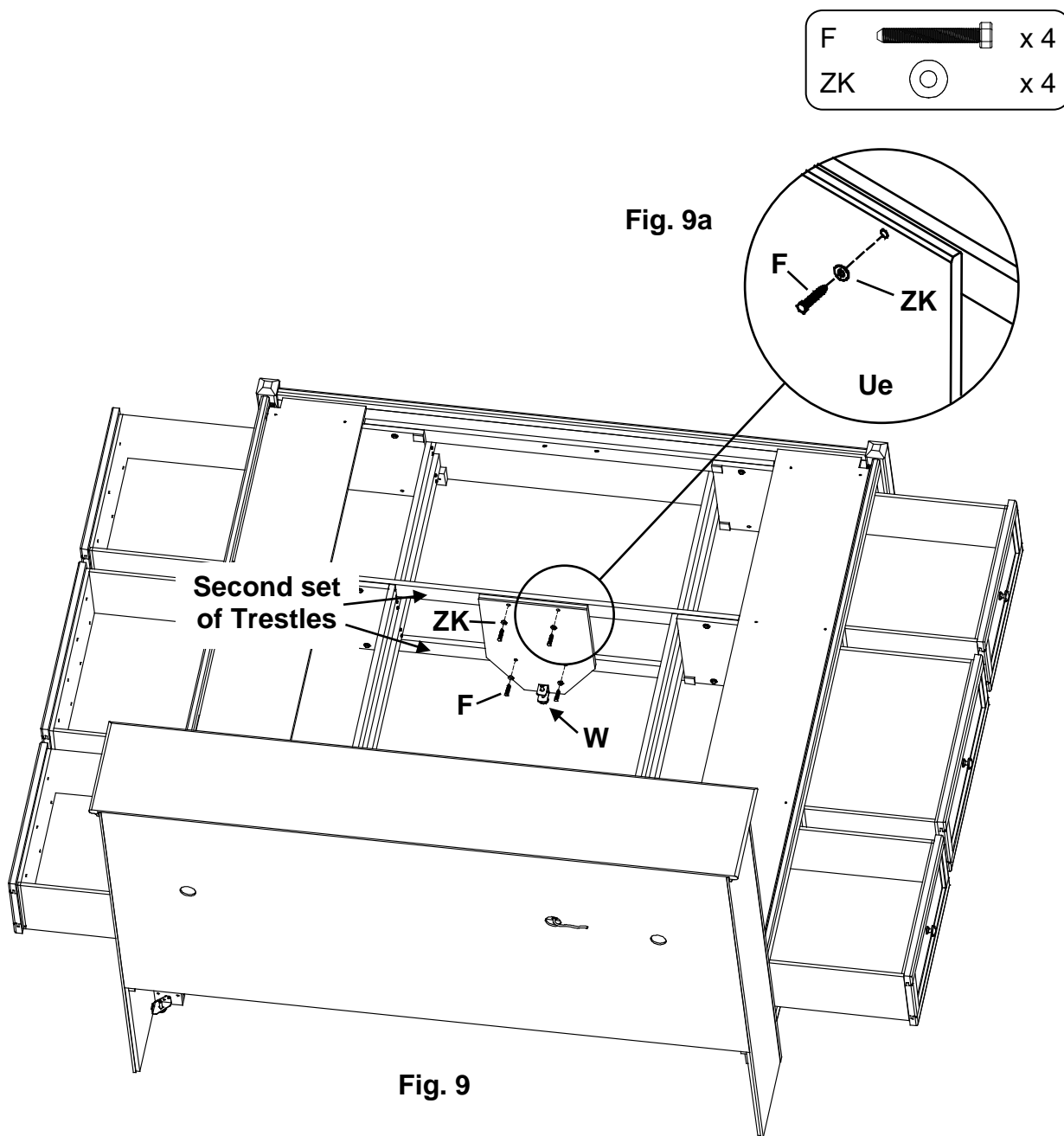

1370AUF1 McKenzie Queen Bookcase Storage Bed

Assembly Instructions

This assembly requires two people.

10. Facing the Footboard, attach the Pedestal Assembly to the Footboard with a 90° Bracket (YH) and four #6 x 1/2" Philtruss Screws (YD). Repeat for the other side. See Figures 10 and 10a.

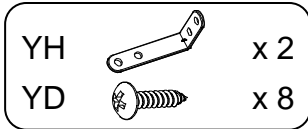

Fig. 10a

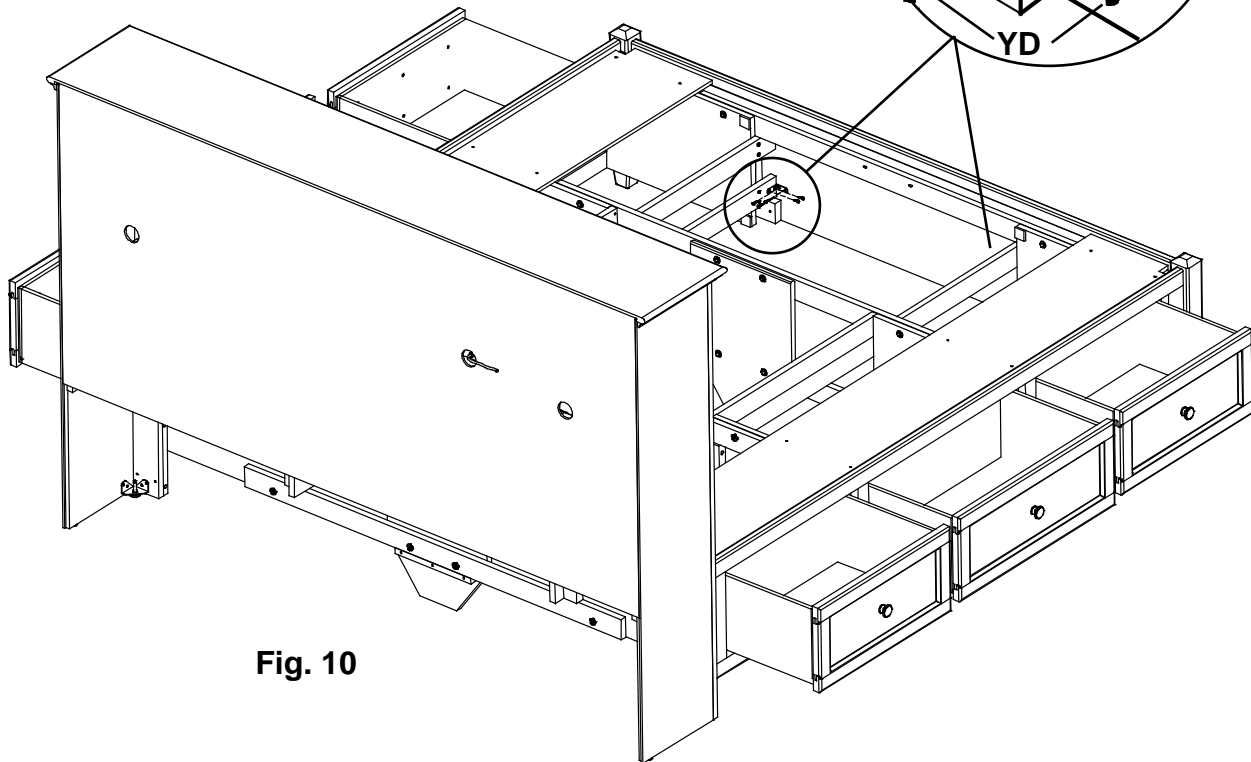
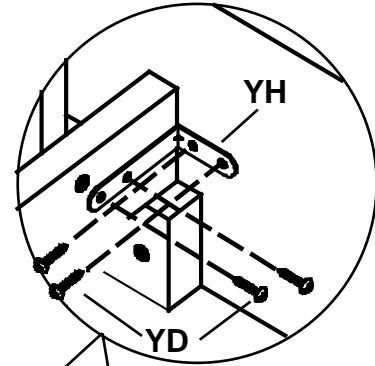

Fig. 10

1370AUF1 McKenzie Queen Bookcase Storage Bed

Assembly Instructions

This assembly requires two people.

11. Place your bed in its final position. Adjust all three Glides (W) found at the bottoms of the Assembled Feet (Ue) so that the Glides just touch the floor. See Figure 11. To level the headboard, stand in the open area in between the two attached deckboards and reach through the front of the platform. See Figure 11. Using a slotted screwdriver, rotate the Large Adjustable Glide (YA) clockwise until it bears weight. Repeat for the opposite side. See Figures 11a and 11b.

This is important if the bookcase headboard sits upon a carpet tack strip.

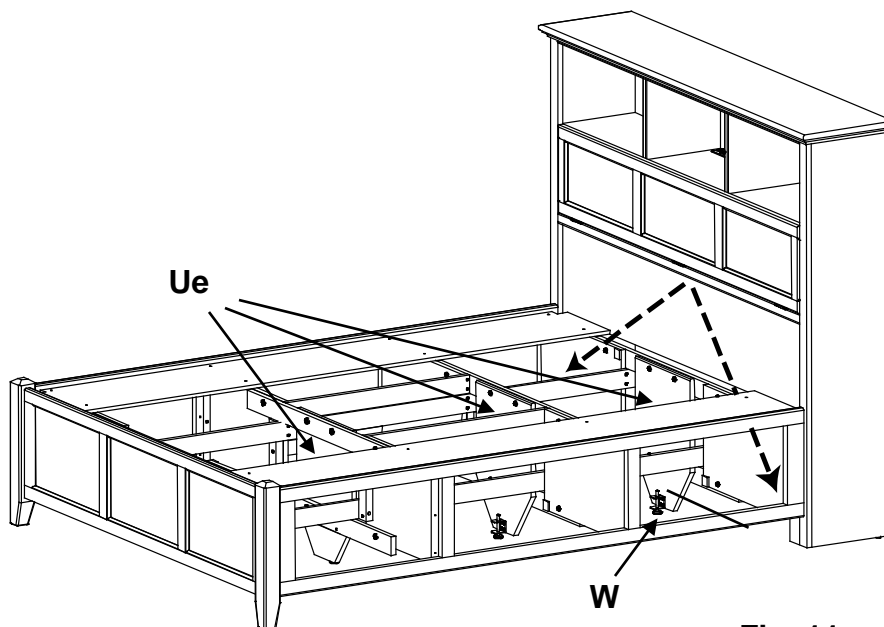

Fig. 11

Drawers removed for illustration purposes.

Fig. 11a

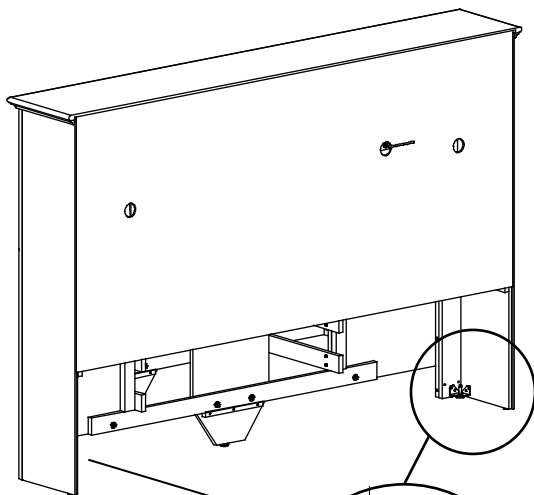
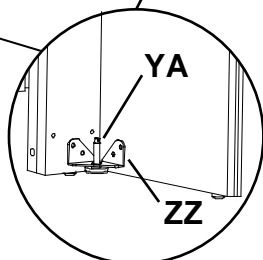

Fig. 11b



The top of the Large Adjustable Glide (YA) is slotted.

1370AUF1 McKenzie Queen Bookcase Storage Bed

Assembly Instructions

This assembly requires two people.

12. To make sure the bed is square, measure the distance between opposing corners. If one of the measurements is larger, tap on a footboard leg until the measurement is equal. See Figure 12.

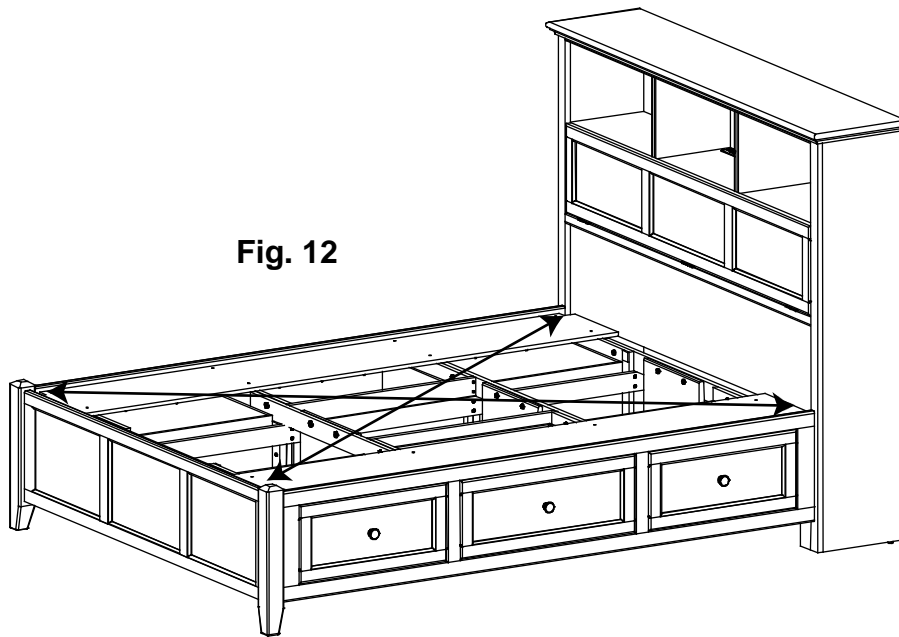

13. Place the Deckboards (Pd) as shown in Figure 13 and secure with twenty-four #8x1-1/4" Black Screws (E). There should be a small gap between each deckboard.

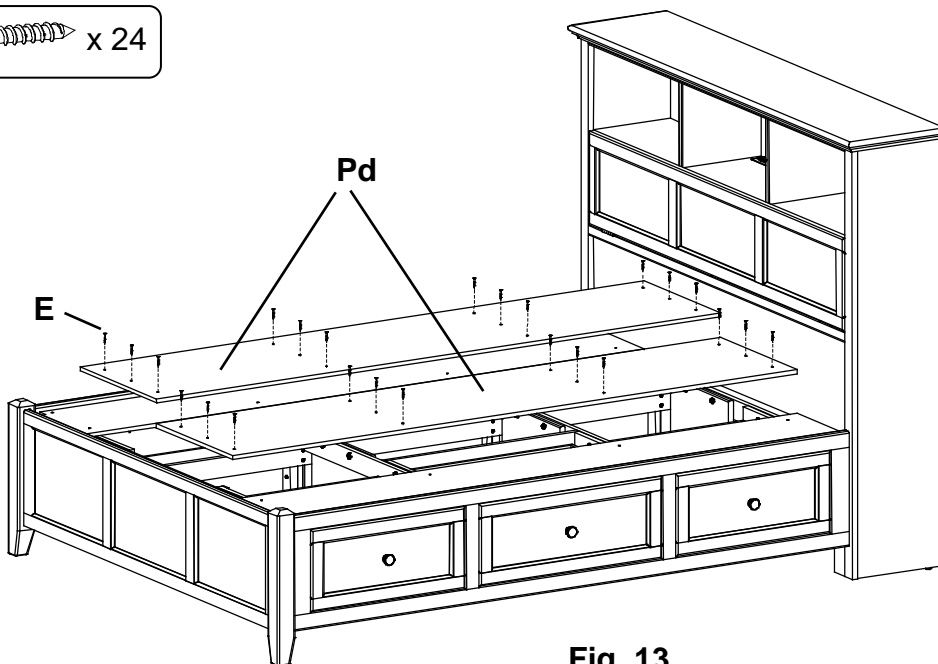
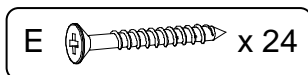

Fig. 13

1370AUF1 McKenzie Queen Bookcase Storage Bed

Assembly Instructions

This assembly requires two people.

14. Open the Door (Rc). To adjust the brake tension on the Door Stay (ZE) turn the screw on the front of the Door Stay clockwise to loosen or counterclockwise to tighten. See Figures 14 and 14a.

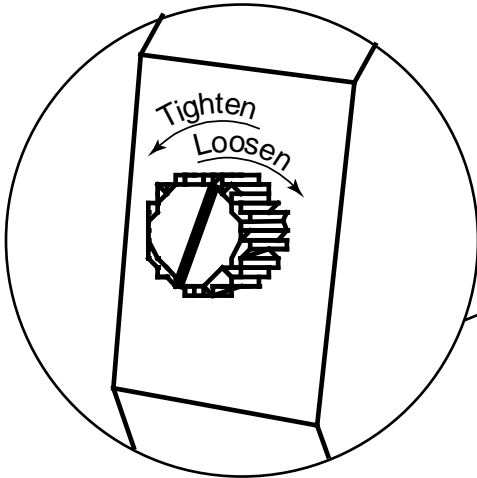

Fig. 14a

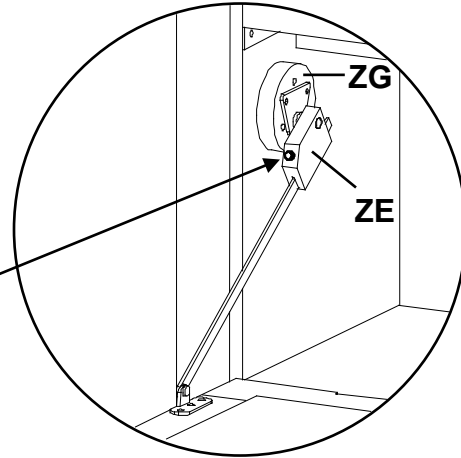

Fig. 14

15. Unwrap the False Bottoms (Sd) and place them on top of the rails in the Headboard Assembly (Aj). Make sure the finger holes face forward as shown in Figure 15. After you have placed your electronics inside the cubbies, use the Wire Clips (ZS) on the underside of the cubbies to secure the wires. Close the door tightly making sure the magnetic catches and plates securely touch.

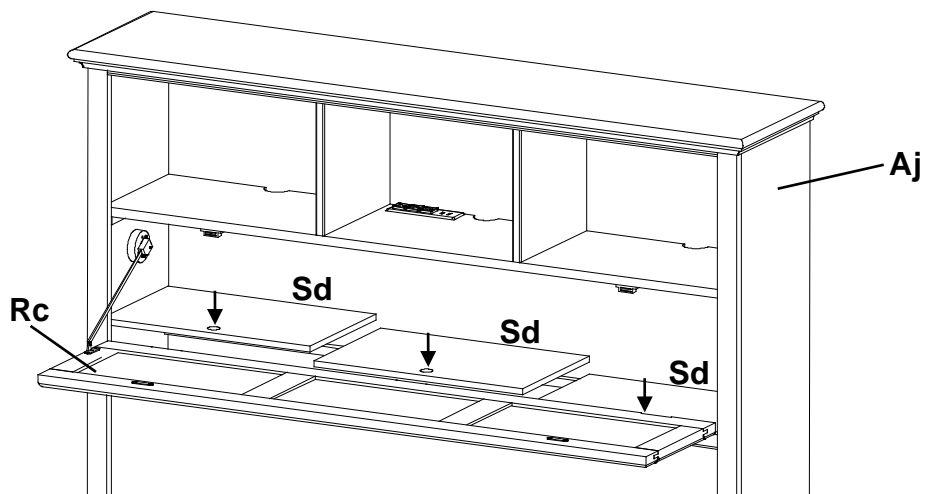

Fig. 15

Whittier Finishing Hints

Checklist of materials

- | | | |
|---|--|--|
| <input type="checkbox"/> Rubber gloves | <input type="checkbox"/> Tack cloth | <input type="checkbox"/> #220 & #320 sandpaper |
| <input type="checkbox"/> Lint-free rags | <input type="checkbox"/> Drop cloth | <input type="checkbox"/> Painter's tape |
| <input type="checkbox"/> Paper towels | <input type="checkbox"/> Stain brushes (poly bristle and foam) | <input type="checkbox"/> Wood glue |
| <input type="checkbox"/> Cotton swabs | | <input type="checkbox"/> Dust mask |

CAUTION: If you have environmental or chemical sensitivities, please take the necessary precautions and use personal protective equipment to aid in limiting your exposure. Personal protective equipment may include but are not limited to gloves, dust masks or respirators.

NOTICE TO CALIFORNIA CUSTOMERS: California Prop 65 requires consumer goods to be labeled if any one of 850+ different chemicals or substances, including wood dust, is present, even in trace amounts. Drilling, sawing, sanding or machining wood products generates wood dust, a substance known to the State of California to cause cancer. **Warning:** This product contains a chemical or substance known to the State of California to cause cancer, birth defects or other reproductive harm. California Health and Safety Code Section 25249.6

Getting started

Assembly Instructions may contain special finishing information or gluing requirements for that item.

Completely read both the Assembly Instructions and these Finishing Hints before you begin your project.

Choosing the finish: Ask your retailer for advice on how to finish bare wood. Choose a finish that meets your expectations for the end use of the product. Will you use it as a work surface as on a desk or kitchen island? Are you matching a finish on existing furniture? The answers to these questions may affect the type of finish you choose.

Where to work: Choose an area that has good light and is well ventilated, warm and dry. If the work area is cold and damp, the wood finishing products may require a longer drying time than the labels indicate. Do not work in a dirty or dusty area – dirt and/or dust can embed in the finish.

Gluing hints

These are general hints. Refer to the Assembly Instructions for detailed information on how to glue your specific product. Use wood glue such as Elmer's Wood Glue, Titebond Wood Glue or the equivalent. Some

instructions call for a slow drying glue. Carefully read the label and instructions of the glue manufacturer. Your unit may not need glue.

1. We strongly recommend that you lay out all the parts and familiarize yourself with how they fit together before assembling with glue. Glue will set up quickly. You can damage parts if you try to reposition any that have been assembled incorrectly.
2. For glue to properly bond, it is very important to apply the wood glue to bare wood. Protect your eyes and blow into holes to clear excess dust. This will help the glue to adhere to a clean surface.
3. If you plan on finishing the product before you assemble it, place painter's tape three-fourths of the way up from the end of a dowel, spindle or tenon. This protects the ends from the finishing product but allows finish application where it will be visible. Finishing products inhibit the bonding properties of wood glue. Remove the tape prior to the final assembly.
4. Avoid getting glue on surfaces to be finished. Most stains or finishes will not penetrate where glue has been spilled. Wet glue can be wiped off with a damp cloth. Follow with a light sanding of the area to ensure a proper finish.
5. It is important to apply an even coat inside holes and slots. Use a small dowel, pencil or cotton swab to spread glue evenly around the inside of the holes. Do not over glue. The tight fit of the spindles or dowels in the holes can cause glue to be pushed to the bottom of the hole. If too much glue is used it will fill the holes and not allow the spindle or dowel to be fully inserted.
6. Glue usually takes several hours to cure or harden but it will set up or grab in several seconds. Once you begin final assembly, proceed quickly.

Finishing hints

1. Use products of the same brand to ensure compatibility. It is not recommended to mix solvent based and water based finishes. *Always read and follow all label directions on the can.*
2. Alder is a porous hardwood and often looks best when following the finishing instructions for softwoods.
3. Use a wood conditioner under oil base stains.



P.O. Box 2827
Eugene, OR 97402 USA
Toll Free: 800-653-3336
Ph: 541-687-0213
Fax: 541-687-2060
www.whittierwood.com

Preparing the surface

1. Sand each piece with #220 grit sandpaper. Sand with the grain of the wood on flat surfaces and opposite the grain on turnings. Some parts may be plywood. Be careful not to sand through the veneer. End grain such as table top ends, seat edges and grooves on turnings accept more stain. Extra sanding in these areas with #320 grit sandpaper reduces stain absorption and creates a more evenly stained piece.
2. When sanding is completed, wipe the surface of your furniture with a lint-free rag or tack cloth. Make sure the item is free of dust before you proceed.

Staining

1. *Always read and follow all label directions.* Stir the stain well before you start. Stir periodically throughout the duration of the project to maintain uniform color consistency.
2. Test stain on an inconspicuous spot on your project. Put at least one coat of your top coat over the test area as it also affects the look of the stain. *Test every type of wood that is in your kit. These are identified in the Assembly Instructions.* Different types of wood may react differently to the stain color. You might need to add a second coat of stain to lighter woods to match the darker woods in your kit.
3. Apply stain with a poly brush or lint-free cloth. Apply stain over a small area and wipe off excess. Working in small areas will make the color easier to control.
4. Cotton swabs are ideal for hard to reach areas.
5. Allow the stain to dry thoroughly before you proceed.

Applying the top coat

1. *Always read and follow all label directions.* Stir your top coat gently; do not shake. Shaking the can creates bubbles that are hard to remove.
2. All surfaces including the underside of table tops and inside drawers must be sealed with at least one layer of a top coat. This will help minimize wood swelling, shrinkage, warping and cupping due to changes in moisture content or temperature.
3. Apply a minimum of two coats when you use polyurethane or varnish (especially on all table top and work surfaces). After allowing the first coat to dry, sand lightly with #320 grit sandpaper. Remove dust with a lint-free rag or tack cloth. For added protection,

apply additional coats. Lightly sand and wipe surface with a lint-free rag or tack cloth between coats.

4. Some finishes tend to slightly raise the grain. This can be easily controlled with a light sanding between coats. Do not use steel wool when you use water-based finishes. Strands of steel fiber caught in the wood can cause rust spots when coated with any water-based product.

Painting

1. *Always read and follow all label directions.* Since there is a large variation between paint manufacturers and products, ask your paint supplier for specific advice on how to best use the paint you purchase. Ask them specifically for advice on finishing bare wood.
2. First coat the wood with a primer. An oil based primer works best for a smooth finish. If you do not wish to use a solvent based primer, water based primer works almost as well. However it may raise the wood grain and require additional sanding.
3. Buy quality brand paint in a satin, semi-gloss, or gloss sheen. Apply a second coat for a smooth finish. Lightly sand between coats using with #320 grit sandpaper so that the second coat will bond well. Be sure to use a tack cloth after sanding to remove any residue. Repeat as desired.
4. No top coat is required when using paint.