

Model #

# 1370FSTI

## McKenzie Queen Bookcase Storage Bed

FST = Fieldstone finish  
*Assembly Instructions*

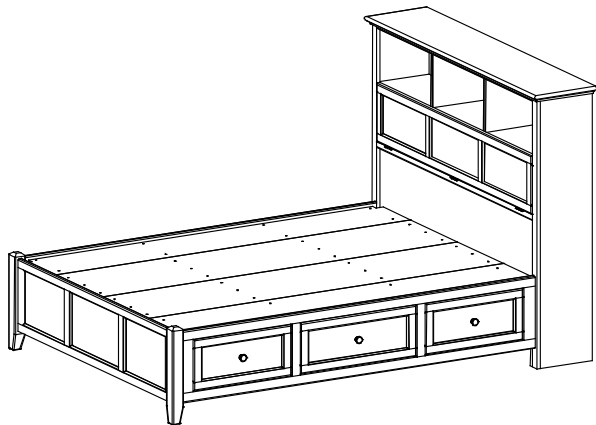

*Thank you for allowing us to help you furnish your home. We are certain you will be delighted with your new furniture for many years to come.*

### IMPORTANT NOTES:

- For normal household use only. *Not* recommended for commercial use.
- Unload items before you move this unit.
- Do not overload the concealed storage areas.
- Do not overload the drawers.
- This assembly requires two people.

### WARNING

Drilling, sawing, sanding or machining wood products can expose you to wood dust, a substance known to the state of California to cause cancer. Avoid inhaling wood dust or use a dust mask or other safeguards for personal protection.

For more information go to: [www.p65warnings.ca.gov/wood](http://www.p65warnings.ca.gov/wood)

This product can expose you to chemicals, including formaldehyde, which are known to the State of California to cause cancer. For more information go to: [www.p65warnings.ca.gov/furniture](http://www.p65warnings.ca.gov/furniture)

**DESIGN SUBJECT TO CHANGE WITHOUT NOTICE.**

### CUSTOMER SERVICE

If you ever have questions about your furniture, please do not hesitate to contact us. In the unlikely event you need a replacement part; we can make those parts available through an authorized Whittier Wood Furniture dealer. If you cannot order replacement parts through your dealer, please contact our customer service department.

**Hours:** Our friendly customer service staff can be reached:

**Monday-Friday 8:00 a.m. to 5:00 p.m. (Pacific Time).**

You may leave a message 24 hours a day, seven days a week.

**Customer Service: 800-653-3336 • Outside the U.S.: 541-687-0213**

**Fax: 541-687-2060 • Email: [info@whittierwood.com](mailto:info@whittierwood.com)**

**Whittier  
Wood**  
FURNITURE

P.O. Box 2827  
Eugene, OR 97402 USA

Production Code:

VN













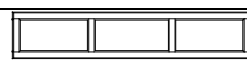

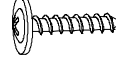
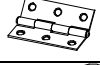

08/17

# 1370FSTI McKenzie Queen Bookcase Storage Bed

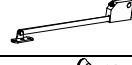
## Parts List

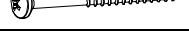
Please identify the parts and check that quantities received match those on this list.  
If you need to replace a part, refer to the following letter and part name.

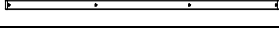
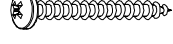
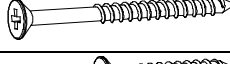
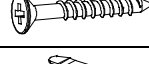
### 1372FSTI Headboard Kit (x1)











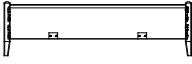
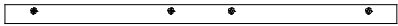

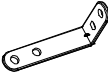

Part	Description	Quantity
Aj	Headboard Assembly 	1
E	#8 x 1-1/4" Black Screw (inserted) 	8
Rc	Assembled Door (attached) 	1
Sd	False Bottom 	3
XA	Top Assembly (attached) 	1
XB	Power Bar and USB (installed) 	1
YA	Large Adjustable Glide (installed) 	2
YB	#8 x 5/8" Pan Head Screw (inserted) 	8
YJ	#8 x 1-3/8" Lo-Profile Screw (inserted) 	8
YL	#8 x 7/8" Black Lo-Profile Screw (inserted) 	4
ZA	Hinge (installed) 	3
ZB	Magnetic Plate (installed) 	2
ZC	Magnetic Catch (installed) 	2
ZE	Door Stay (attached) 	1
ZF	#6 x 5/8" Undercut Screw ZN (inserted) 	4
ZG	Door Stay Support (attached) 	1
ZH	#6 x 1-1/4" Black Pan Head Screw (inserted) 	3
ZI	#6 x 5/8" Undercut Screw AB (inserted) 	22
ZJ	#6 x 5/8" Philtruss Screw (inserted) 	12
ZM	Door Cleat (attached) 	1
ZN	#8 x 1-1/4" Pan Head Screw (inserted) 	9
ZO	#8 x 2-1/4" Black Screw (inserted) 	6
ZP	#8 x 1" Black Screw (inserted) 	16
ZQ	Left Bracket (attached) 	2

**1370FSTI McKenzie Queen Bookcase Storage Bed**  
*Parts List*

<b>Part</b>	<b>Description</b>		<b>Quantity</b>
ZR	Right Bracket (attached)		2
ZS	Wire Clip Screw (attached)		6
ZT	Tack Glide (attached)		4
ZZ	Corner Brace (attached)		2

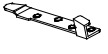
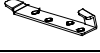

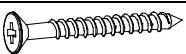







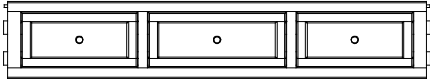
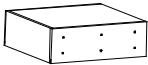



**1370FSTI McKenzie Queen Bookcase Storage Bed**  
*Parts List*

## 1373FSTI Footboard Kit (x1)

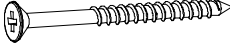
Part	Description		Quantity
Be	Footboard Assembly		1
De	Trestle With T-Nuts		7
E	#8 x 1-1/4" Black Screw		33 (9 inserted)
F	1/4" x 1-3/4" Hex Bolt		26
Ue	Assembled Foot		3
W	Adjustable Glide (installed)		3
YD	#6 x 1/2" Philtruss Screw		8
YH	90° Bracket		2
YM	#10 x 3/4" Pan Head Screw (inserted)		12
ZK	18mm Washer		26
ZP	#8 x 1" Black Screw (inserted)		16
ZQ	Left Bracket (attached)		2
ZR	Right Bracket (attached)		2
ZU	1/4" T-Nut (inserted)		28
ZX	#8 x 1-5/8" Black Screw (inserted)		4
ZY	Foot Bracket (attached)		3

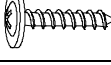
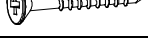
**1370FSTI McKenzie Queen Bookcase Storage Bed**  
*Parts List*

**1318FSTe Pedestal Kit (x2)**

Part	Description	Quantity
E	#8 x 1-1/4" Black Screw (inserted) 	30
Id	Pedestal Kit 	1
J	Small Drawer Box (assembled) 	2
Kd	Large Drawer Box (assembled) 	1
L	Small Drawer Face (attached) 	2
Md	Large Drawer Face (attached) 	1
Ne	#8 x 1-1/2" Machine Screw Tuscan (installed) 	3
O	Knob (attached) 	3
Pd	Deckboard 	1
Q	20" Drawer Slides (installed) 	3 sets
T	#8 x 2" Black Screw (inserted) 	12
YD	#6 x 1/2" Philtruss Screw (inserted) 	18
YE	#6 x 3/4" Philtruss Screw (inserted) 	18
YL	#8 x 7/8" Black Lo-Profile Screw (inserted) 	20
ZP	#8 x 1" Black Screw (inserted) 	16
ZQ	Left Bracket (attached) 	2
ZR	Right Bracket (attached) 	2
ZX	#8 x 1-5/8" Black Screw (inserted) 	16

# 1370FSTI McKenzie Queen Bookcase Storage Bed

## Assembly Instructions

This assembly requires two people.

**Tools Required:** Phillips screwdriver, Slotted screwdriver, 7/16" open end or box end wrench and Tape measure.

1. Remove the Trestles (De) and Assembled Feet (Ue) from the backs of the Footboard (Be) and place them off to the side. See Figures 1 and 1a.

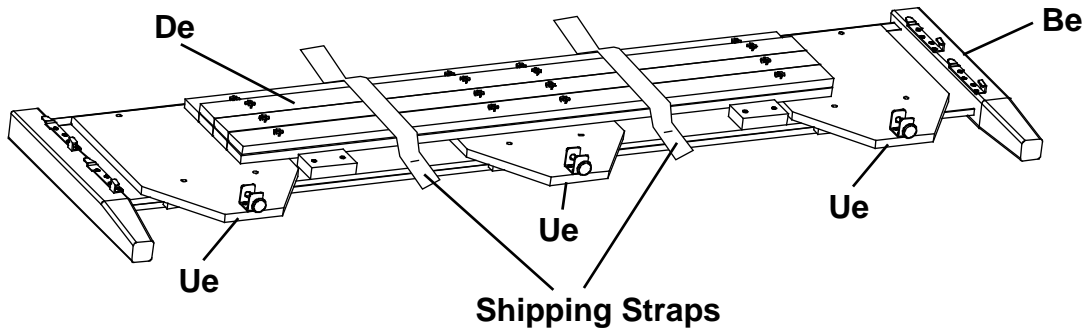

Fig. 1

2. Place both Pedestals (Id) approximately 63" apart as shown in Figure 2.

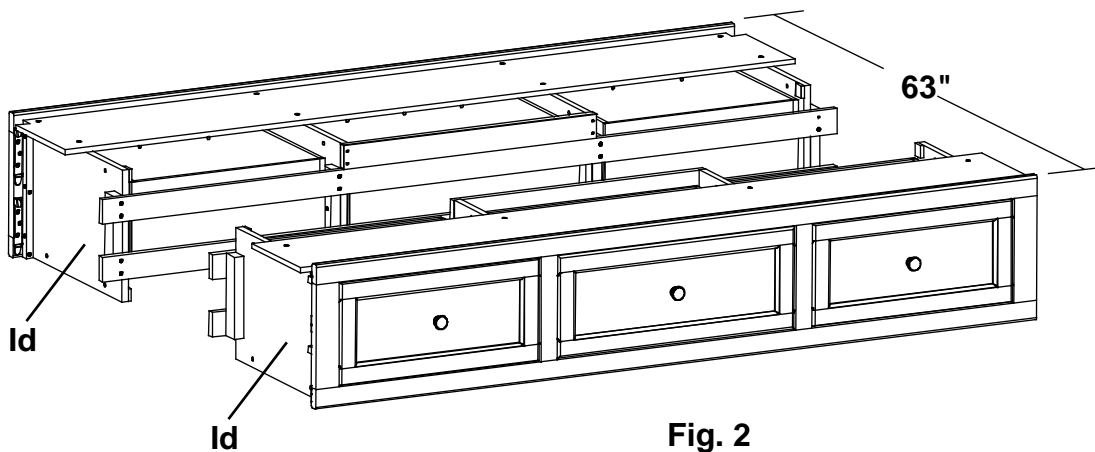

Fig. 2

# 1370FSTI McKenzie Queen Bookcase Storage Bed

## Assembly Instructions

This assembly requires two people.

- To attach the Footboard (Be) to the Pedestal Assembly (Id), align the Brackets and slide the Pedestal Assembly down on to the Footboard (Be). See Figures 3 and 3a.

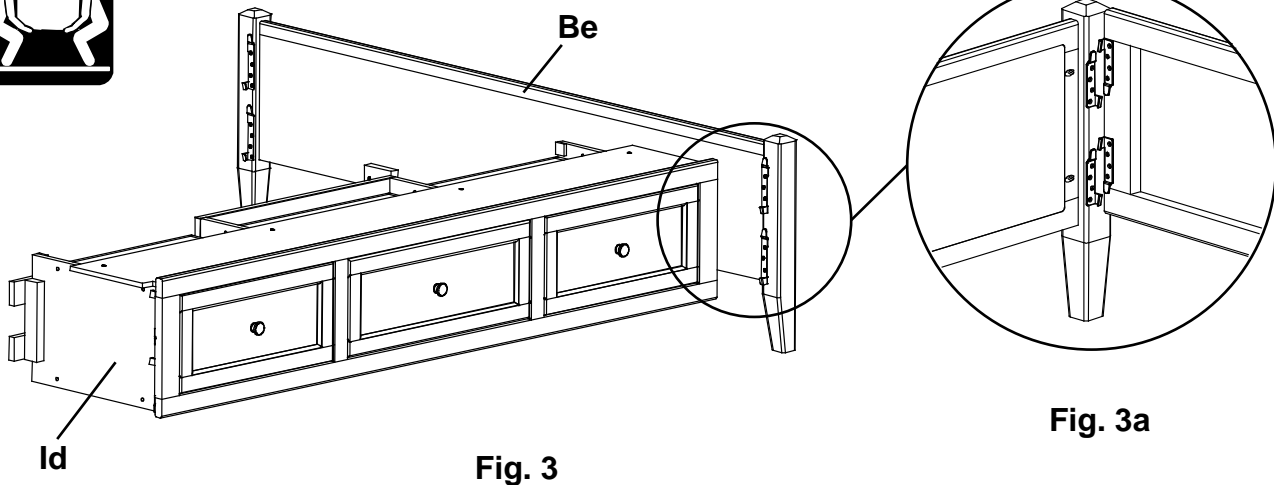

- Repeat step three for the left side.

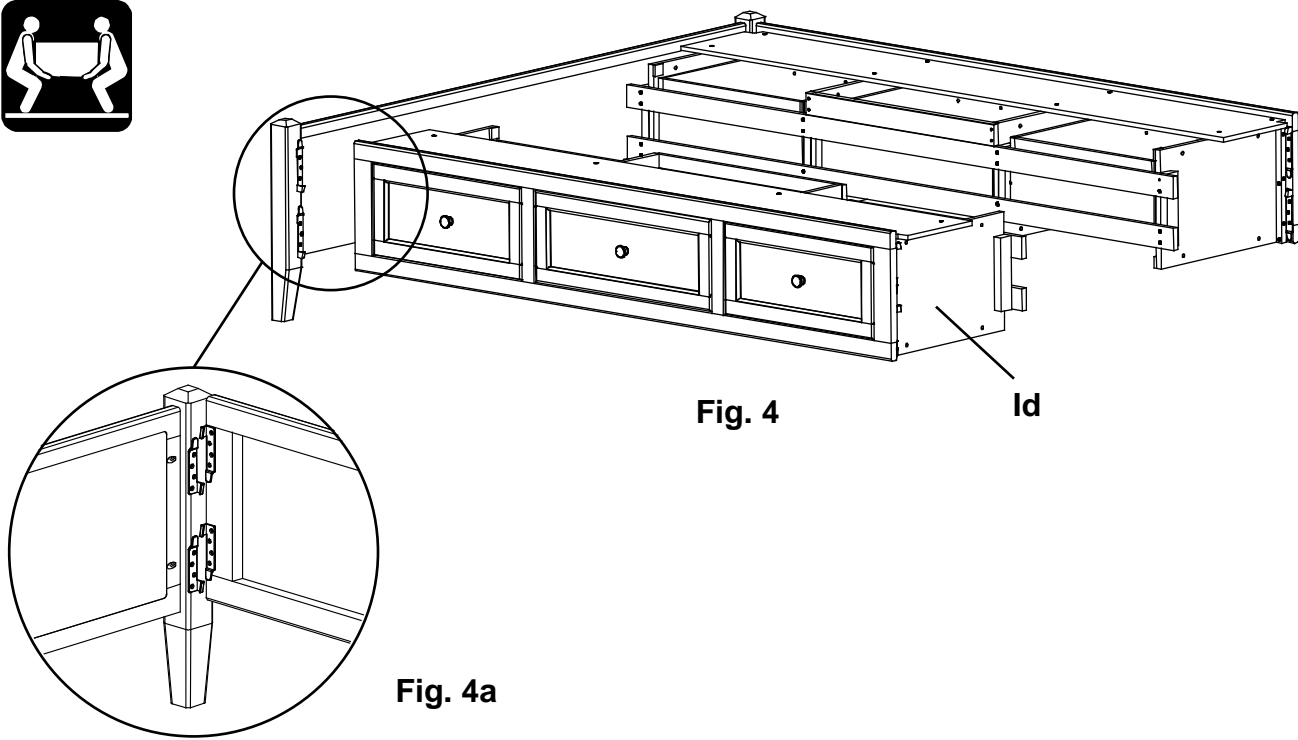

# 1370FSTI McKenzie Queen Bookcase Storage Bed

## Assembly Instructions

This assembly requires two people.

5. Align the Brackets on both sides and slide the Pedestal/Footboard assembly down on to the Headboard (Aj). See Figure 5.

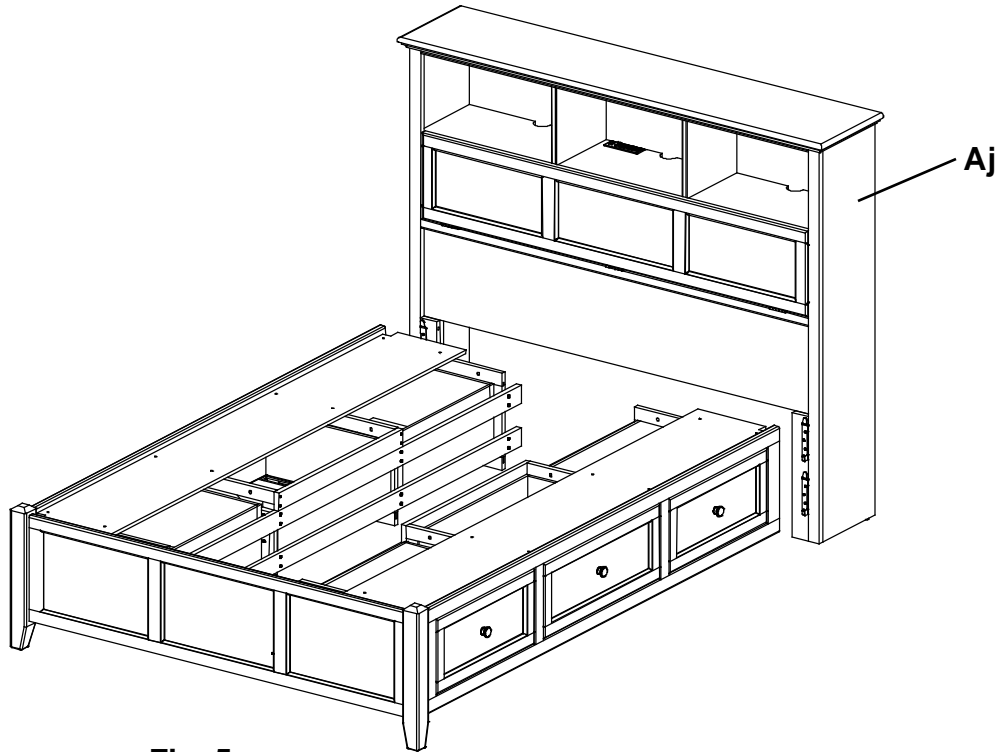

Fig. 5



# 1370FSTI McKenzie Queen Bookcase Storage Bed

## Assembly Instructions

This assembly requires two people.

- Open the drawers. Face the Footboard and stand in between the first and second braces. Place a Trestle with T-Nuts (De) on the outside surfaces of the first upper left and right braces so that the T-Nuts (ZU) sit near the top. See Figure 6a. Line up the upper edges of the trestle and braces so they are nearly flush. Insert two 1/4" x 1-3/4" Hex Bolts (F) and Washers (ZK) and tighten. Repeat for the second upper brace.

Place a Trestle with T-Nuts (De) on the outside surface of the second lower brace so that the T-Nuts (ZU) sit near the bottom. Line up the bottom edges of the trestle and braces so they are nearly flush. Insert two 1/4" x 1-3/4" Hex Bolts (F) and Washers (ZK) and tighten. See Figures 6 and 6a.

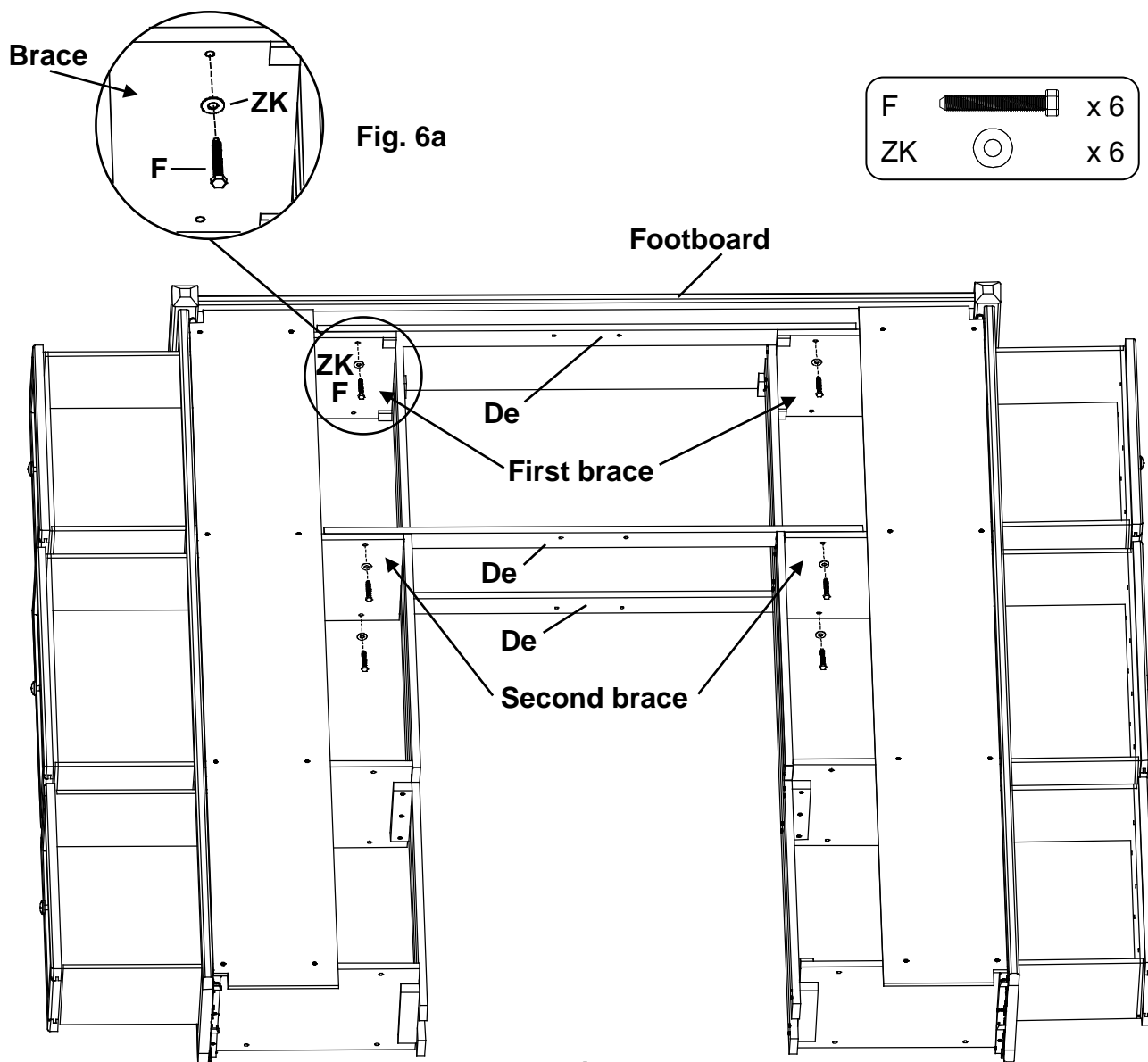

Fig. 6

*Headboard removed for illustration purposes.*

# 1370FSTI McKenzie Queen Bookcase Storage Bed

## Assembly Instructions

This assembly requires two people.

7. Face the Headboard and stand in between the third and fourth braces. Place a Trestle with T-Nuts (De) on the outside surfaces of the third **upper** left and right braces so the T-nuts sit near the top. See Figures 7 and 7a. Line up the upper edges of the trestle and braces so they are nearly flush. Insert two 1/4" x 1-3/4" Hex Bolts (F) and Washers (ZK) and tighten.

Place a Trestle with T-Nuts on the outside surface of the third left and right **lower** braces so that the T-nuts sit near the bottom. Line up the bottom edges of the trestle and braces so they are nearly flush. Insert two 1/4" x 1-3/4" Hex Bolts (F) and Washers (ZK) and tighten. See Figures 7 and 7a.

Repeat for the fourth braces.

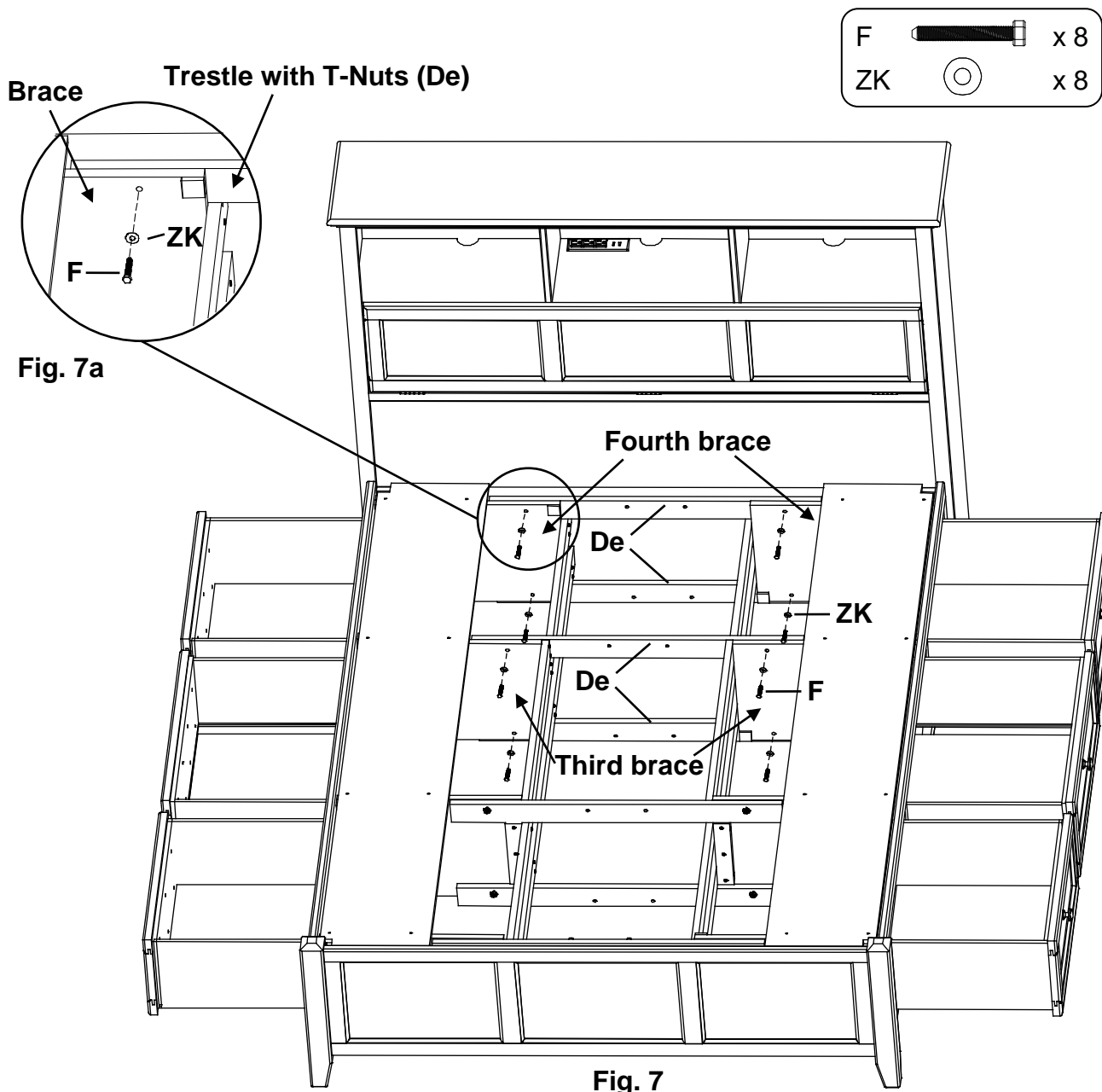

# 1370FSTI McKenzie Queen Bookcase Storage Bed

## Assembly Instructions

This assembly requires two people.

8. **NOTE:** There are blocks mounted on the back side of the Footboard to support the end of the pedestal eliminating the need for an Assembled Foot in this position where it would be easily visible. Do not attach an Assembled Foot in the position near the footboard.

Facing the Headboard, place two Assembled Feet (Ue) on the inside faces of the third and fourth upper and lower Trestles. Attach with Washers (ZK) and 1/4" x 1-3/4" Hex Bolts (F). See Figures 8 and 8a.

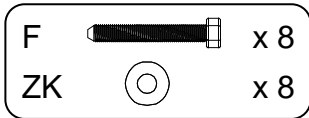

Trestle with T-Nuts (De)

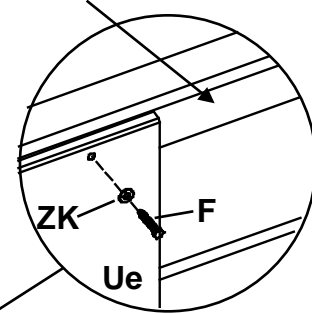

Fig. 8a

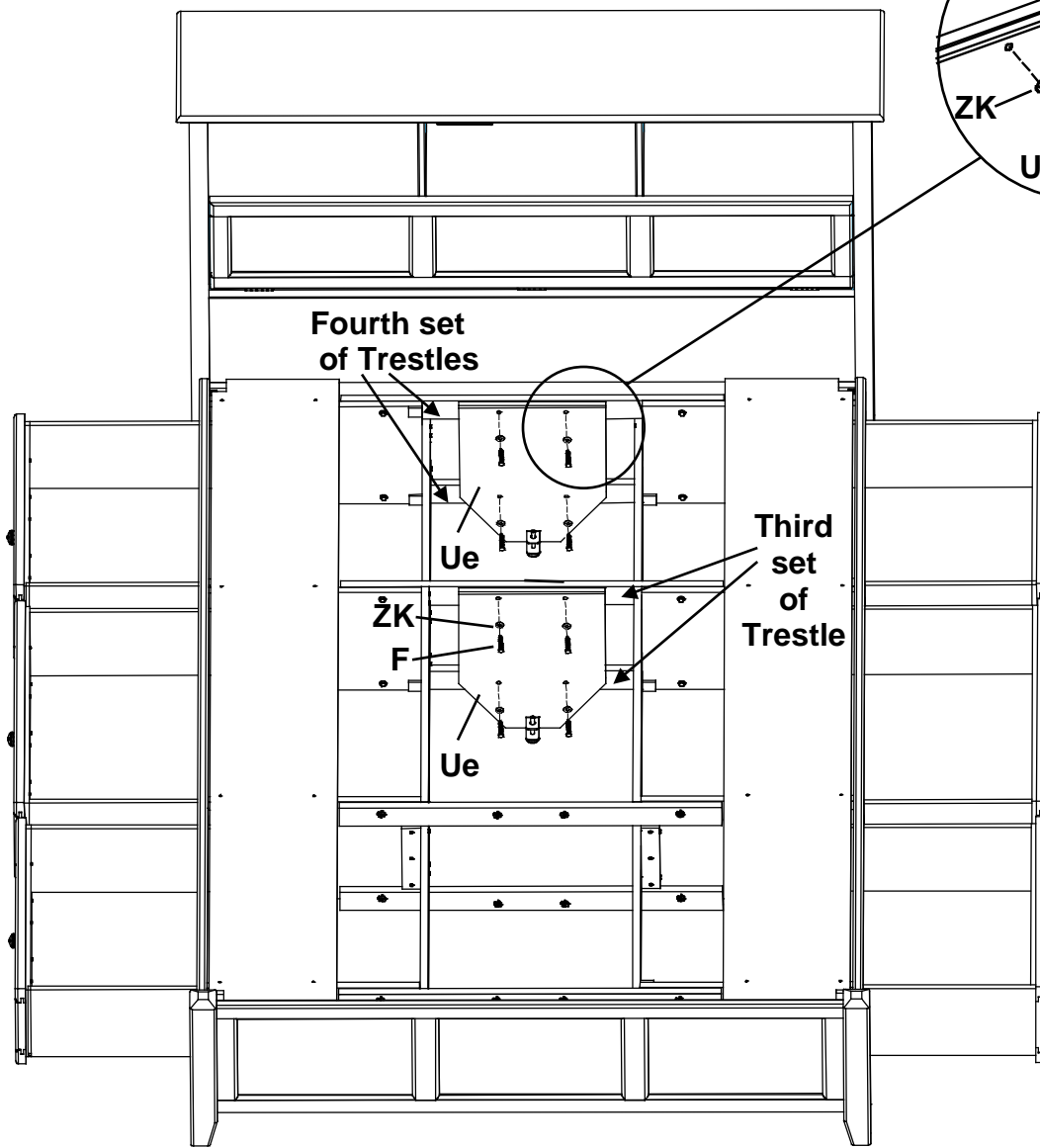

Fig. 8

# 1370FSTI McKenzie Queen Bookcase Storage Bed

## Assembly Instructions

This assembly requires two people.

9. **NOTE:** There are blocks mounted on the back side of the Footboard to support the end of the pedestal eliminating the need for an Assembled Foot in this position where it would be easily visible. Do not attach an Assembled Foot in the position near the footboard.

Facing the Footboard, place an Assembled Foot (Ue) on the inside of the second set of Trestles and attach with four Washers (ZK) and four 1/4" x 1-3/4" Hex Bolts (F). See Figures 9 and 9a.

Adjust all three Glides (W) found at the bottoms of the Assembled Feet so that the Glides just touch the floor.

**IMPORTANT:** Make sure the Glides touch the floor and carry weight.

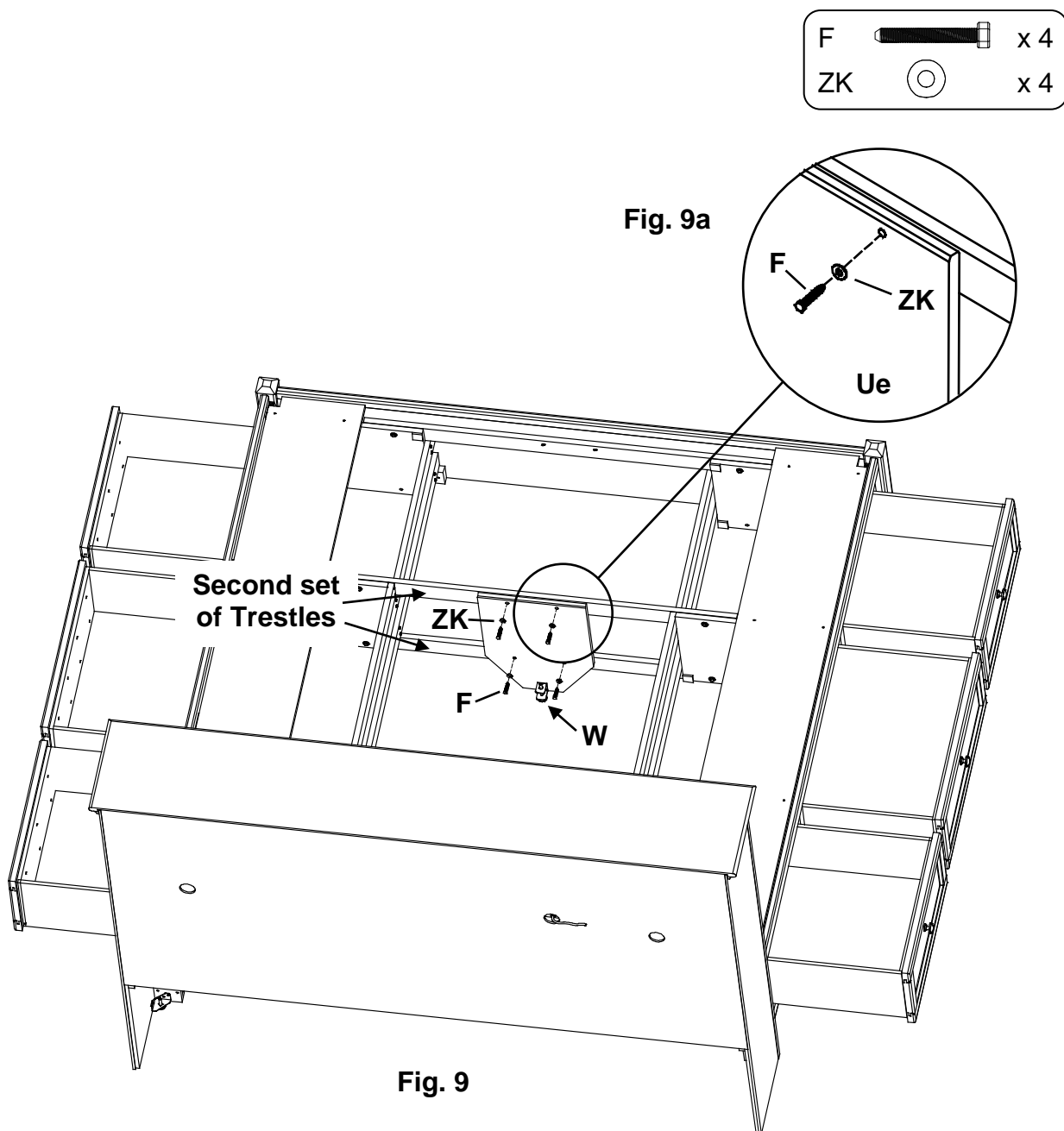

# 1370FSTI McKenzie Queen Bookcase Storage Bed

## Assembly Instructions

This assembly requires two people.

10. Facing the Footboard, attach the Pedestal Assembly to the Footboard with a 90° Bracket (YH) and four #6 x 1/2" Philtruss Screws (YD). Repeat for the other side. See Figures 10 and 10a.

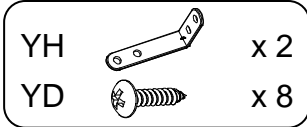

Fig. 10a

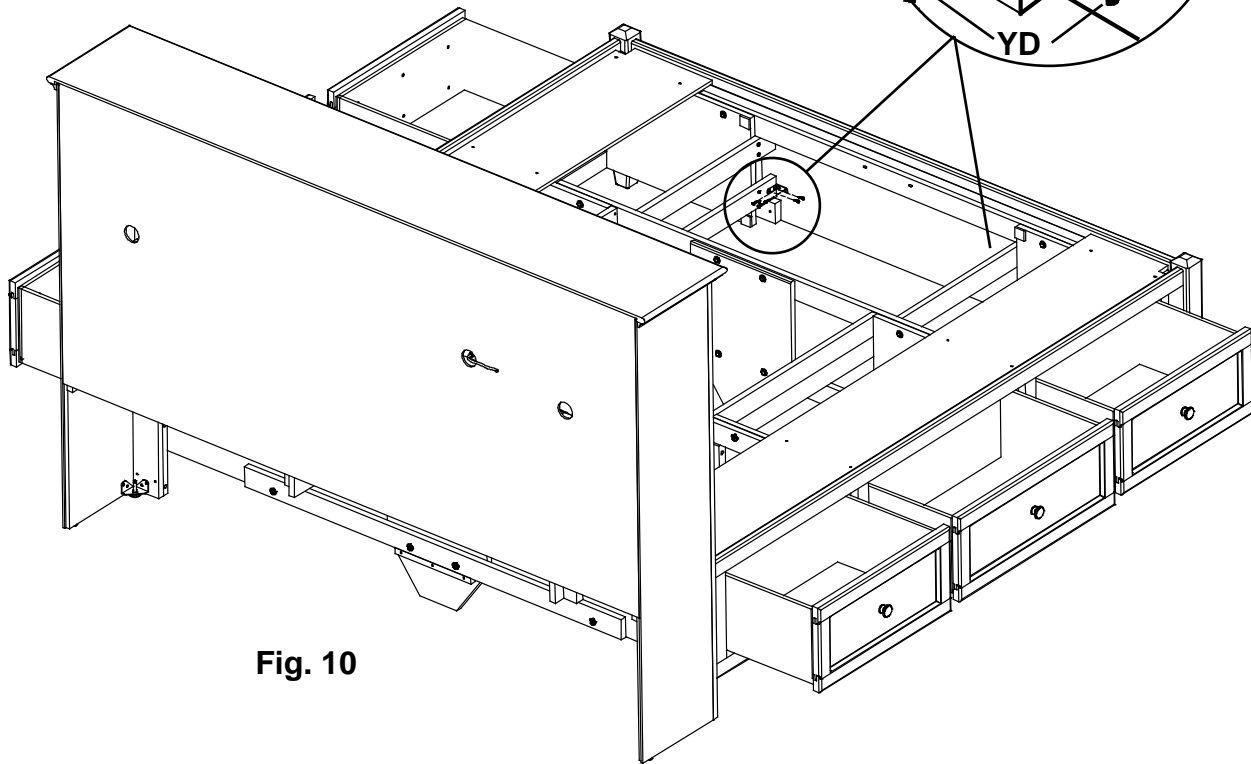
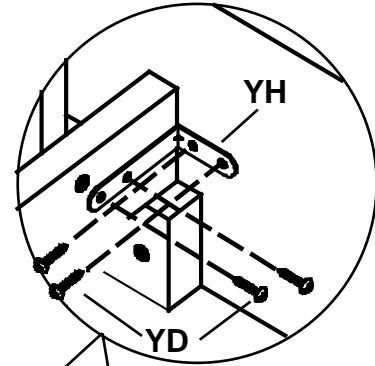

Fig. 10

# 1370FSTI McKenzie Queen Bookcase Storage Bed

## Assembly Instructions

This assembly requires two people.

11. Place your bed in its final position. Adjust all three Glides (W) found at the bottoms of the Assembled Feet (Ue) so that the Glides just touch the floor. See Figure 11. To level the headboard, stand in the open area in between the two attached deckboards and reach through the front of the platform. See Figure 11. Using a slotted screwdriver, rotate the Large Adjustable Glide (YA) clockwise until it bears weight. Repeat for the opposite side. See Figures 11a and 11b.

**This is important if the bookcase headboard sits upon a carpet tack strip.**

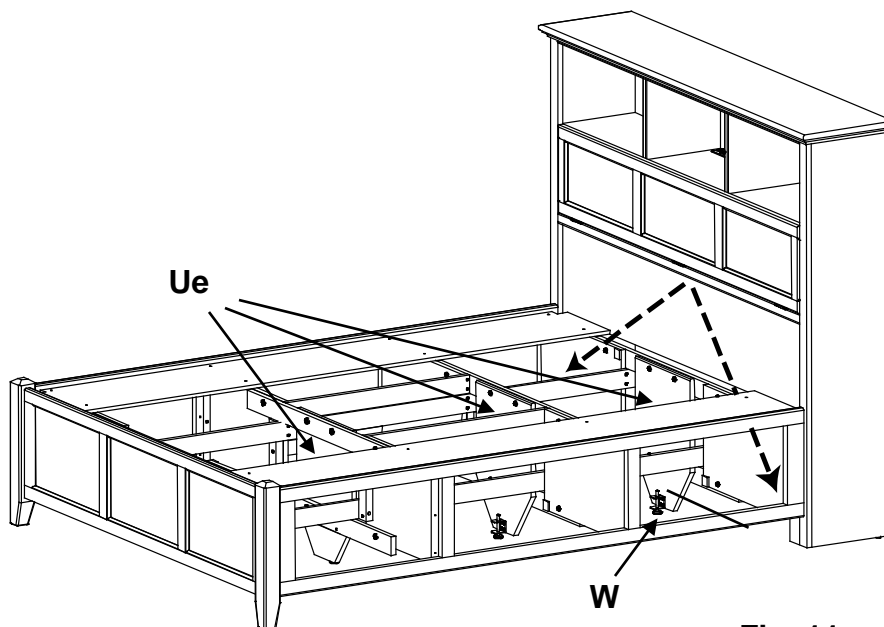

Fig. 11

Drawers removed for illustration purposes.

Fig. 11a

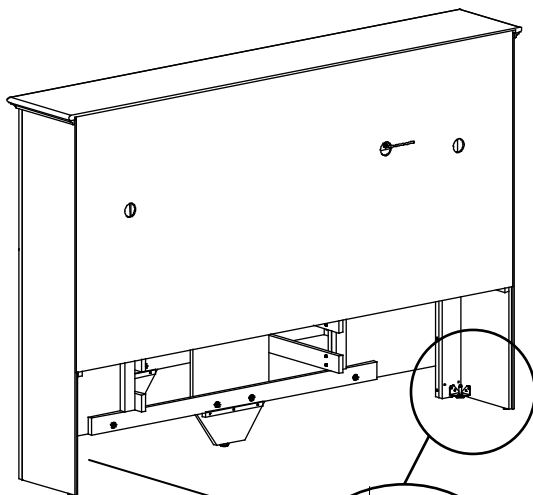
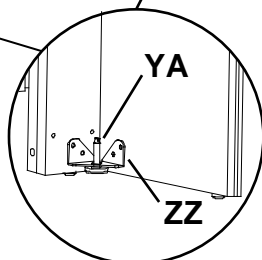

Fig. 11b



The top of the Large Adjustable Glide (YA) is slotted.

# 1370FSTI McKenzie Queen Bookcase Storage Bed

## Assembly Instructions

This assembly requires two people.

12. To make sure the bed is square, measure the distance between opposing corners. If one of the measurements is larger, tap on a footboard leg until the measurement is equal. See Figure 12.

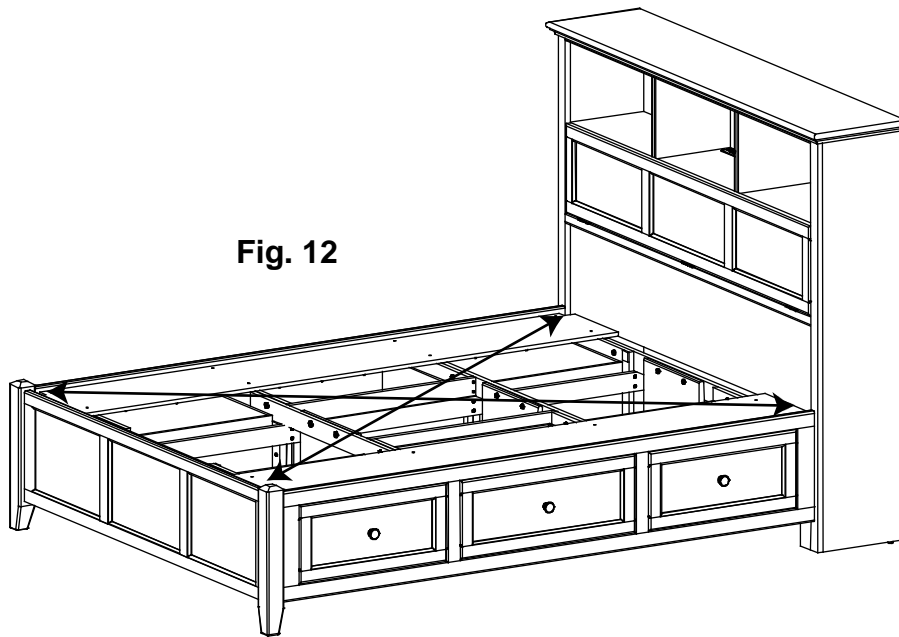

13. Place the Deckboards (Pd) as shown in Figure 13 and secure with twenty-four #8x1-1/4" Black Screws (E). There should be a small gap between each deckboard.

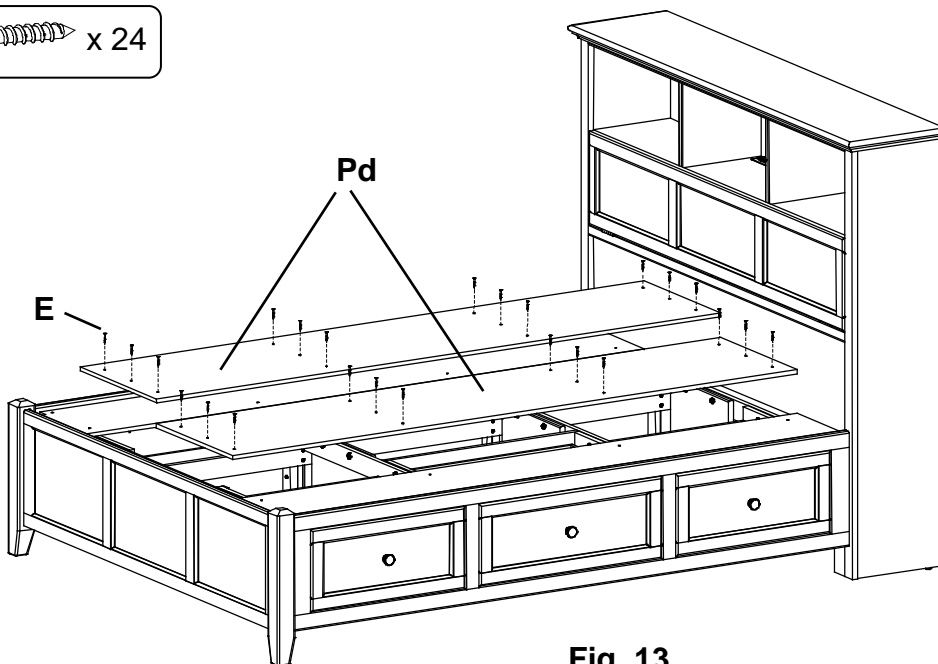
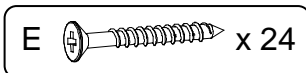

Fig. 13

# 1370FSTI McKenzie Queen Bookcase Storage Bed

## Assembly Instructions

This assembly requires two people.

14. Open the Door (Rc). To adjust the brake tension on the Door Stay (ZE) turn the screw on the front of the Door Stay clockwise to loosen or counterclockwise to tighten. See Figures 14 and 14a.

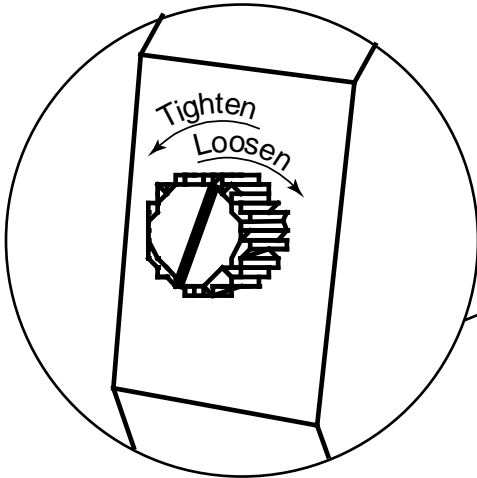

Fig. 14a

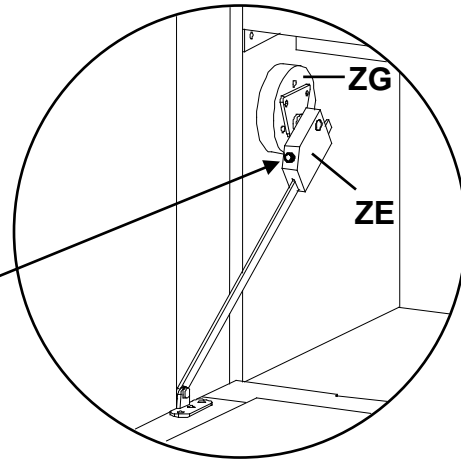

Fig. 14

15. Unwrap the False Bottoms (Sd) and place them on top of the rails in the Headboard Assembly (Aj). Make sure the finger holes face forward as shown in Figure 15. After you have placed your electronics inside the cubbies, use the Wire Clips (ZS) on the underside of the cubbies to secure the wires. Close the door tightly making sure the magnetic catches and plates securely touch.

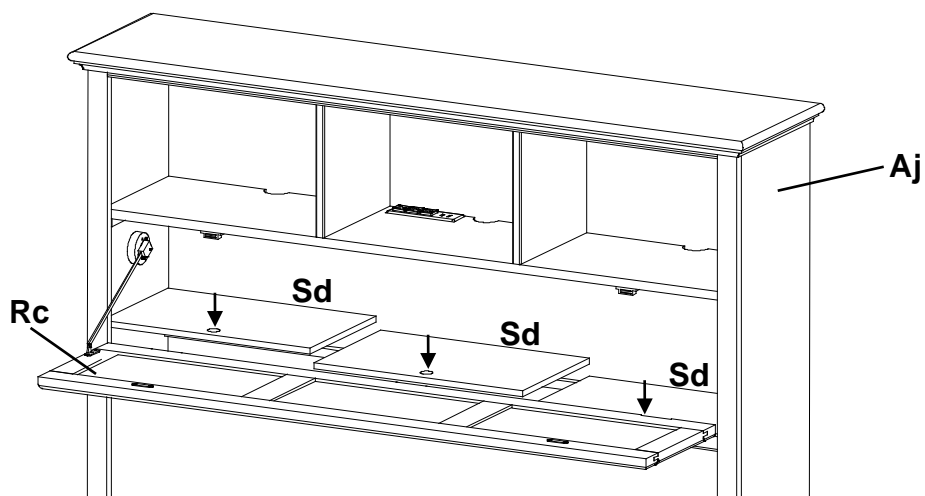

Fig. 15