

Center Wall Unit

AFGAC = Glazed Antique Cherry finish

AFCFAF = Caffè finish

Assembly Instructions

Model #

**1610AFGAC;
1610AFCFAF**
Center Wall Unit

**1611AFGACa;
1611AFCFAFa**
Center Wall Unit
with doors

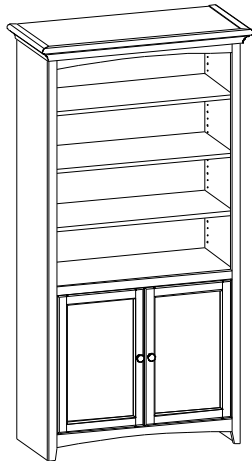
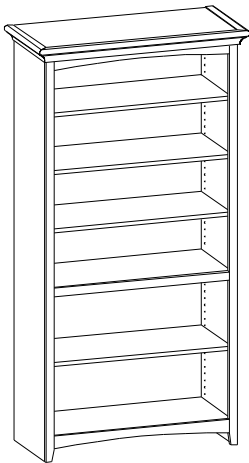

Congratulations!

This fine piece of furniture will make a gorgeous addition to your home. For the best results, read the Assembly Instructions before you begin your project.

IMPORTANT NOTES:

- For normal household use only. *Not* recommended for commercial use.
- Do not climb, sit or stand on this piece of furniture.
- Unload items before you move this unit.
- Do not overload the shelves on this unit.
- Before loading or moving this unit, check all screws and supports for tightness.
- For maximum stability, attach unit to the wall using the enclosed hardware as per instructions.
- Before you begin your project, completely read the Assembly Instructions.
- Store this item: 1- in its box; 2- in a dry place; 3- in temperatures that range from 40°F to 90°F (not on a cold and possibly damp cement floor).
- Periodically inspect your furniture for any loose glue joints, screws or any other problem that might affect the stability of your furniture. Tighten or repair as needed.

⚠ WARNING

Serious or fatal crushing injuries can occur from furniture tip-over. Use of tip-over restraints may only reduce but not eliminate the risk of tip-over.

To help prevent tip-over:

- Place heaviest items in the bottom drawers.
- Unless specifically designed to accommodate, do not set TVs or other heavy objects on top of this product.
- Never allow children to climb or hang on drawers, doors or shelves.
- Never open more than one drawer at a time.

Warning: At least one tipping restraint kit was included with your piece of Whittier Wood Furniture. When you receive your furniture, be sure to find and properly install the tipping restraint(s). If you cannot locate the restraint(s), please contact us immediately for replacement.

Notice to California Customers

California Prop 65 requires consumer goods to be labeled if any one of 850+ different chemicals or substances, including wood dust, is present even in trace amounts. Drilling, sawing, sanding or machining wood products generates wood dust, a substance known to the State of California to cause cancer. **Warning:** This product contains a chemical or substance known to the State of California to cause cancer, birth defects or other reproductive harm. *California Health and Safety Code Section 25249.6*

DESIGN SUBJECT TO CHANGE WITHOUT NOTICE.



CALL US FIRST! Do not return this item to the store

Service Policy: We will replace any part that is defective, missing or damaged during assembly. For a replacement part, directly contact Whittier Wood Products customer service department by phone, fax, mail or email.

To Order: Provide the finish and furniture model number (upper portion of this page), the part letter, production code, quantity needed, reason for replacement and your full name, address and telephone number.

Hours: Our friendly customer service staff can be reached Monday-Friday 7:00 a.m. to 5:00 p.m. (Pacific Time). You may leave a message 24 hours a day, seven days a week.

Parts ship from our Eugene, Oregon factory within one or two business days from the time we receive your request. Please allow five to ten business days for delivery.

800-653-3336 • Outside the U.S. or Canada: 541-687-0213 • Fax: 541-687-2060
www.whittierwood.com • P.O. Box 2827 • Eugene, Oregon 97402, U.S.A.



P.O. Box 2827
Eugene, OR 97402 USA

Production Code:









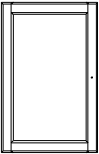

VN

06/14

**1610AFGAC; 1610AFCAF Center Wall Unit without doors &
1611AFGACa; 1611AFCAFfa Center Wall Unit with doors**

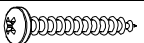
Parts List

Please identify the parts and check that quantities received match those on this list.
If you need to replace a part, refer to the following letter and part name.

Part	Description	Quantity	
		1610AFGAC 1610AFCAF	1611AFGACa 1611AFCAFfa
A	Top (attached) 	1	1
B	Adjustable Shelf (attached) 	4	4
C	Door (attached) 	0	2
D	Shelf Bracket (installed) 	16	16
E	#6 x 1/2" Undercut Screw (inserted) 	16	16
F	Knob (attached) 	0	2
Ga	#8 x 1-1/2" Machine Screw Tuscan (installed) 	0	2
H	#8 x 1" Pan Head Screw (inserted) 	8	8
I	Nylon Insert (inserted) 	4	4
J	Small Adjustable Glide (installed) 	4	4
K	Hinge (attached)	0	4
L	Hinge Plate (attached)	0	4
M	Hex Bumper (attached) 	0	2
TB	Bookcase Tipping Restraint	1 set	1 set

1611 shown in the illustrations.

**1610AFGAC; 1610AFCAF Center Wall Unit without doors &
1611AFGACa; 1611AFCAFfa Center Wall Unit with doors**
Assembly Instructions

Tool Required: Phillips Screwdriver, Pencil, Rubber Mallet or Padded Hammer

1. To move the adjustable shelves:

Determine where you want to place the Adjustable Shelves (A). Remove the #6 x 1/2" Undercut Screws (E) from the underside of the shelf and take out the Shelf and Shelf Brackets (D). Insert the Shelf Brackets (flat side down) into the four different holes and insert the shelf. You may secure them by inserting #6 x 1/2" Undercut Screws (E). See Figures 1 and 1a.

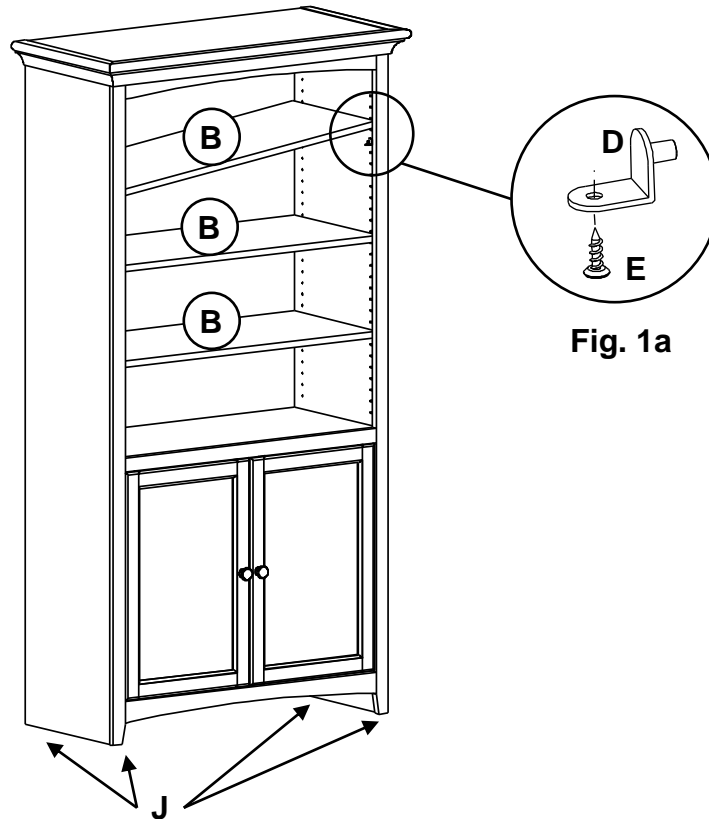

2. Level the unit using the Adjustable Glides (J) located on the bottom of the unit. See Figure 1.



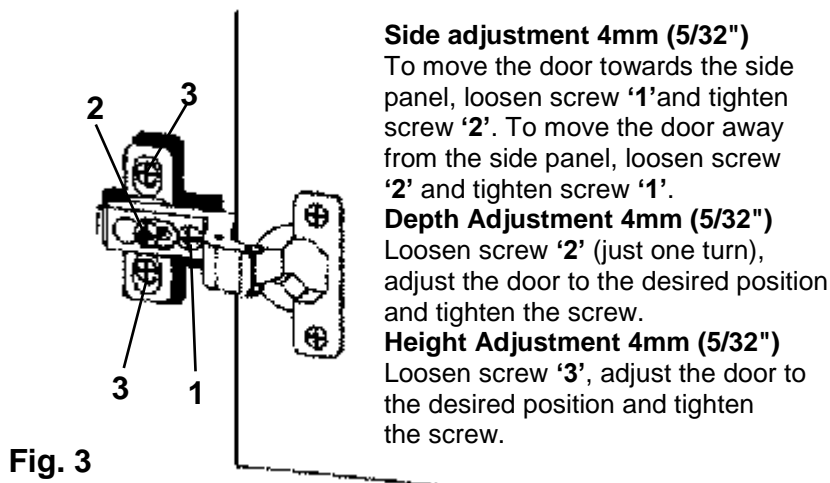

3. To adjust the doors, follow the instructions below.

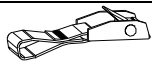
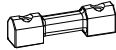

**1610AFGAC; 1610AFCAF Center Wall Unit without doors &
1611AFGACa; 1611AFCAF a Center Wall Unit with doors**
Assembly Instructions

Bookcase Tipping Restraint Instructions

Before you begin this assembly, identify each part and make sure the quantities received match what is on this list. If you need to replace a part, contact Whittier Wood Furniture customer service and refer to the following list for its name and letter code.

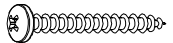
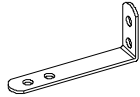
Part	Description		Quantity
A	Cam Buckle and Short Strap (installed)		1
B	Plastic Bracket (installed)		1
C	1" x 1000mm Long Strap (installed)		1
D	#8 x 3" Pan Head Screw		2
F	Washer (installed)		1
G	#8 x 5/8" Pan Head Screw		2 (1 inserted)
H	#8 x 1-1/4" Pan Head Screw		1
I	"L" Angle Bracket		1

If you have a stone or tile floor or do not wish to drive screws into the corner of the baseboard and floor see the instruction included inside the tipping restraint kit for an alternate installation.

Continued on Page 5

**1610AFGAC; 1610AFCAF Center Wall Unit without doors &
1611AFGACa; 1611AFCAFfa Center Wall Unit with doors**
Assembly Instructions

4. Decide where you want to place the bookcase in your room. Mark the baseboard with a pencil mark directly behind the location where the tipping restraint is attached to your item. Move the item away from the wall far enough to allow you to access the spot where the baseboard meets the floor. Position the straps and Plastic Bracket (B) as shown in Figures 4 and 4a with the angled corners of the Plastic Bracket (B) firmly placed against the seam of the baseboard and floor. Attach by driving #8 x 3" Pan Head Screws (D) through the holes in the Plastic Bracket (B) into the seam below the baseboard where it meets the floor. See Figures 4 and 4a.

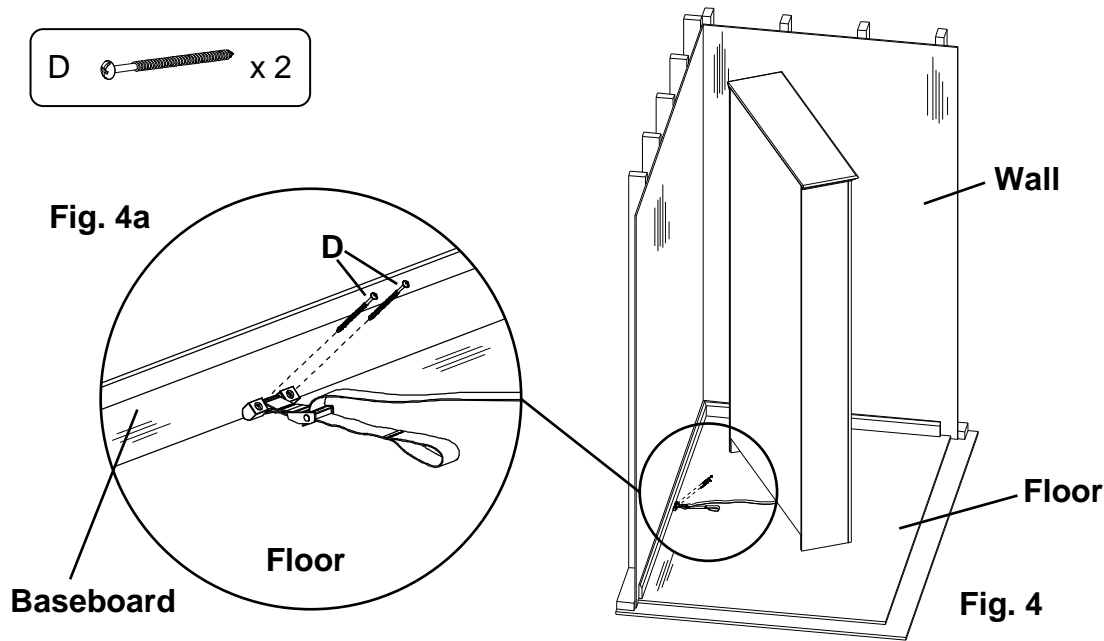

5. Move the item back into position against the wall and reach underneath the bookcase to grasp the loop in the free end of the strap. Pull the free end of the strap until portion between the Cam Buckle (A) and the bottom of the item is tight. See Figures 5 and 5a. If you need to move the bookcase reach beneath and locate the buckle which connects the two sections of the strap and depress the release lever, then pull on the section of strap that is between the buckle and the bottom of the furniture until there is enough slack to allow you to pull the item away from the wall.

