

# McKenzie Media Consoles

**GAC = Glazed Antique Cherry finish**

**CAF = Caffè finish**

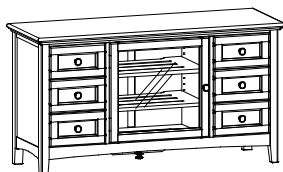
*Assembly Instructions*

Model #

**2068GACh**

**2068CAFh**

**54"W McKenzie  
Media Console**

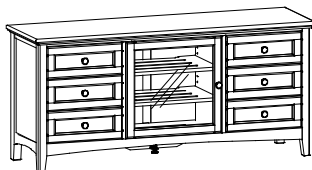


Model #

**2069GACh**

**2069CAFh**

**64"W McKenzie  
Media Console**



*Thank you for allowing us to help you furnish your home. We are certain you will be delighted with your new furniture for many years to come.*

## IMPORTANT NOTES:

- For normal household use only. *Not* recommended for commercial use.
- Do not climb, sit or stand on this piece of furniture.
- Do not overload the drawers or shelves.
- Unload items before you move this unit.



- Handle the glass plates with care. Glass is fragile.
- This assembly requires two people.

## **WARNING**

Serious or fatal crushing injuries can occur from furniture tip-over. Use of tip-over restraints may only reduce but not eliminate the risk of tip-over.

### To help prevent tip-over:

- Place heaviest items in the bottom drawers.
- Unless specifically designed to accommodate, do not set TVs or other heavy objects on top of this product.
- Never allow children to climb or hang on drawers, doors or shelves.
- Never open more than one drawer at a time.

**Warning:** At least one tipping restraint kit was included with your piece of Whittier Wood Furniture. When you receive your furniture, be sure to find and properly install the tipping restraint(s). If you cannot locate the restraint(s), please contact us immediately for replacement.

Drilling, sawing, sanding or machining wood products can expose you to wood dust, a substance known to the state of California to cause cancer. Avoid inhaling wood dust or use a dust mask or other safeguards for personal protection.

For more information go to: [www.p65warnings.ca.gov/wood](http://www.p65warnings.ca.gov/wood)

This product can expose you to chemicals, including formaldehyde, which are known to the State of California to cause cancer.

For more information go to: [www.p65warnings.ca.gov/furniture](http://www.p65warnings.ca.gov/furniture)

**DESIGN SUBJECT TO CHANGE WITHOUT NOTICE.**

## CUSTOMER SERVICE

If you ever have questions about your furniture, please do not hesitate to contact us. In the unlikely event you need a replacement part; we can make those parts available through an authorized Whittier Wood Furniture dealer. If you cannot order replacement parts through your dealer, please contact our customer service department.

**Hours:** Our friendly customer service staff can be reached:

**Monday-Friday 8:00 a.m. to 5:00 p.m. (Pacific Time).**

You may leave a message 24 hours a day, seven days a week.

**Customer Service: 800-653-3336 • Outside the U.S.: 541-687-0213**

**Fax: 541-687-2060 • Email: [info@whittierwood.com](mailto:info@whittierwood.com)**

**Whittier  
Wood**  
FURNITURE

P.O. Box 2827  
Eugene, OR 97402 USA

Production Code:


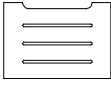



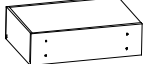

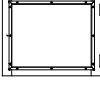

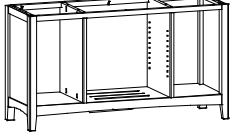



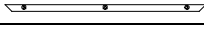
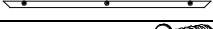


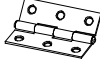

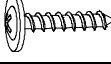
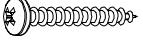
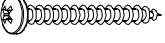

VN

03/17

**2068GACH 2068CAFh 54"W McKenzie Media Console &  
2069GACH 2069CAFh 64"W McKenzie Media Console**


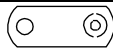







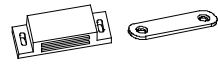

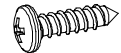
*Parts List*

Please identify the parts and check that quantities received match those on this list.  
If you need to replace a part, refer to the following letter and part name.

Part	Description	Quantity	
		2068GACH 2068CAFh	2069GACH 2069CAFh
A	Top Assembly 	1	1
Bb	Adjustable Shelf 	2	2
C	Knob (attached) 	7	7
Dg	#8 x 1-1/2" Machine Screw Tuscan (installed) 	7	7
E	Drawer Face (installed) 	6	6
F	Drawer Box (inserted) 	6	6
G	16" Drawer Slides (pre-installed sets) 	6	6
Ha	Door Frame 	1	1
la	Door Glass (attached) 	1	1
Jd	Case 	1	1
L	Shelf Bracket (installed) 	8	8
M	#6 x 1/2" Undercut Screw (inserted) 	8	8
Nb	Removable Back (attached) 	2	2
O	Door Glass Support Rail (attached) 	2	2
P	Door Glass Support Stile (attached) 	2	2
Q	#6 x 3/4" Flat Head Screw (inserted) 	12	12
S	#6 x 5/8" Philtruss Screw (inserted) 	16	16
U	Hinge (attached) 	2	2
X	Small Adjustable Glide (installed) 	4	4
Yg	#8 x 7/8" Black Lo-Profile Screw (inserted) 	24	24
ZA	#8 x 1" Pan Head Screw (inserted) 	4	4
ZB	#8 x 1-1/4" Pan Head Screw (inserted) 	14	16
ZD	#8 x 1-1/4" Black Screw (inserted) 	5	6

**2068GACH 2068CAFh 54"W McKenzie Media Console &  
2069GACH 2069CAFh 64"W McKenzie Media Console**

*Parts List*

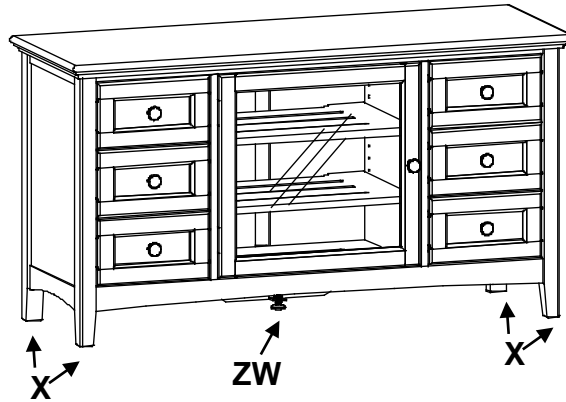
Part	Description		Quantity	
			2068GACH 2068CAFh	2069GACH 2069CAFh
ZG	Drawer Stop (attached)		4	4
ZH	Turn Button (attached)		4	4
ZI	#6 x 5/8" Undercut Screw ZN (inserted)		0 (GAC) 12 (CAF)	0 (GAC) 12 (CAF)
ZJ	#6 x 1/2" Philtruss Screw (inserted)		36	36
ZK	#6 x 3/4" Philtruss Screw (inserted)		36	36
ZS	Insert Nut (inserted)		4	4
ZT	#8 x 1-3/8" Lo-Profile Screw (inserted)		6	6
ZV	Foot Bracket (attached)		1	1
ZW	Adjustable Glide (installed)		1	1
ZX	Tuscan Magnetic Lock & Plate (pre-installed sets)		2	2
ZY	#6 x 5/8" Undercut Screw AB (inserted)		16 (GAC) 4 (CAF)	16 (GAC) 4 (CAF)
ZZ	#10 x 3/4" Pan Head Screw (inserted)		4	4
TS	Media Tipping Restraint (attached)		1 set	1 set

*2068 shown in the illustrations.*

**2068GACH 2068CAFh 54"W McKenzie Media Console &  
2069GACH 2069CAFh 64"W McKenzie Media Console**  
*Assembly Instructions*

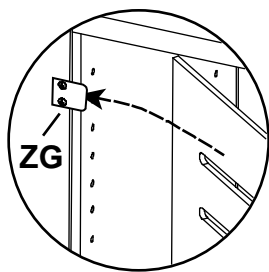
**Tool Required: Phillips Screwdriver, Pencil.**

1. Place the console at its final destination. Rotate the Adjustable Glides (X) found at the corners of the unit and (ZW) at the bottom of the Center Foot until the unit is level. See Figure 1.

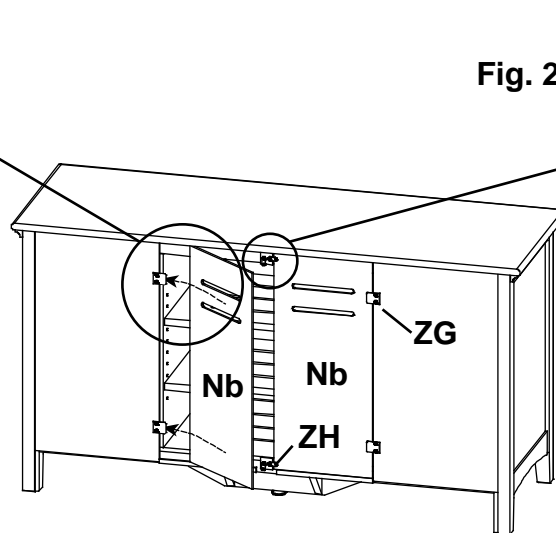


**Fig. 1**

2. You may want to remove the Removable Backs (Nb) so that you can fit your media units into the console more easily. To do so, unlock the Turn Button (ZH) as shown in Figures 2 and 2b. Slide the backs away and place them off to the side. To put them back into place, slide the backs behind the Drawer Stops (ZG) and position the Turn Button so that it is locked. See Figures 2a and 2b.

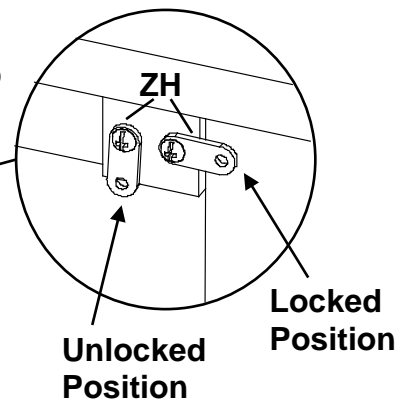


**Fig. 2a**



**Fig. 2**

**Fig. 2b**

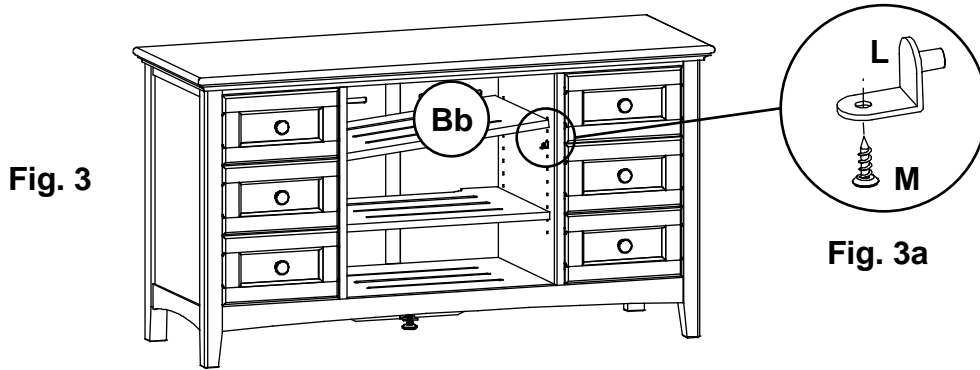


**2068GACH 2068CAFh 54"W McKenzie Media Console &  
2069GACH 2069CAFh 64"W McKenzie Media Console**  
*Assembly Instructions*

---

3. To move the Adjustable Shelves (Bb), remove the #6 x 1/2" Undercut Screws (M) and the Shelves (Bb). Reposition the Shelf Brackets (L) to the desired positions, replace the shelf and insert the screws. See Figures 3 and 3a.

*Door removed for illustration purposes.*



*Continued on Page 6*

**2068GACH 2068CAFh 54"W McKenzie Media Console &  
2069GACH 2069CAFh 64"W McKenzie Media Console**  
*Assembly Instructions*

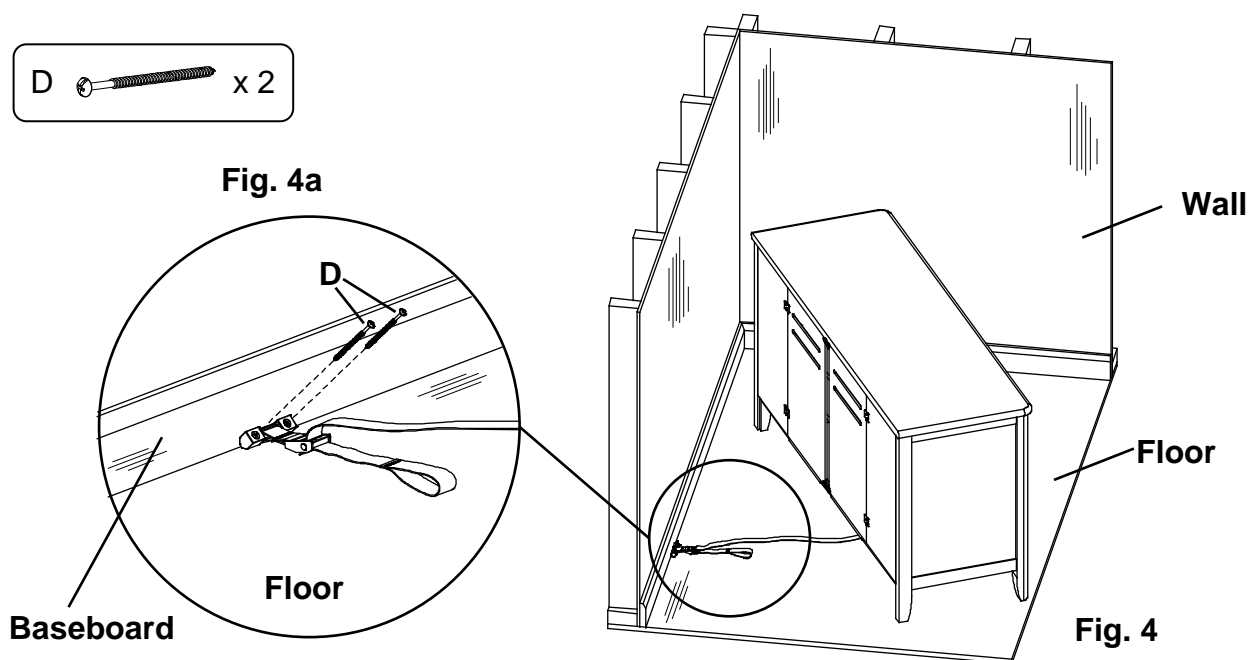
## Furniture Tipping Restraint Instructions

Before you begin this assembly, identify each part and make sure the quantities received match what is on this list. If you need to replace a part, contact Whittier Wood Furniture customer service and refer to the following list for its name and letter code.

Part	Description	Quantity
A	Cam Buckle and Short Strap (installed)	1
B	Plastic Bracket (installed)	1
C	1" x 1000mm Long Strap (installed)	1
D	#8 x 3" Pan Head Screw	2
E	#10 x 1" Oval Head Screw (inserted)	1
F	Washer	1

**If you have a stone or tile floor or do not wish to drive screws into the corner of the baseboard and floor see the instruction included inside the tipping restraint kit for an alternate installation.**

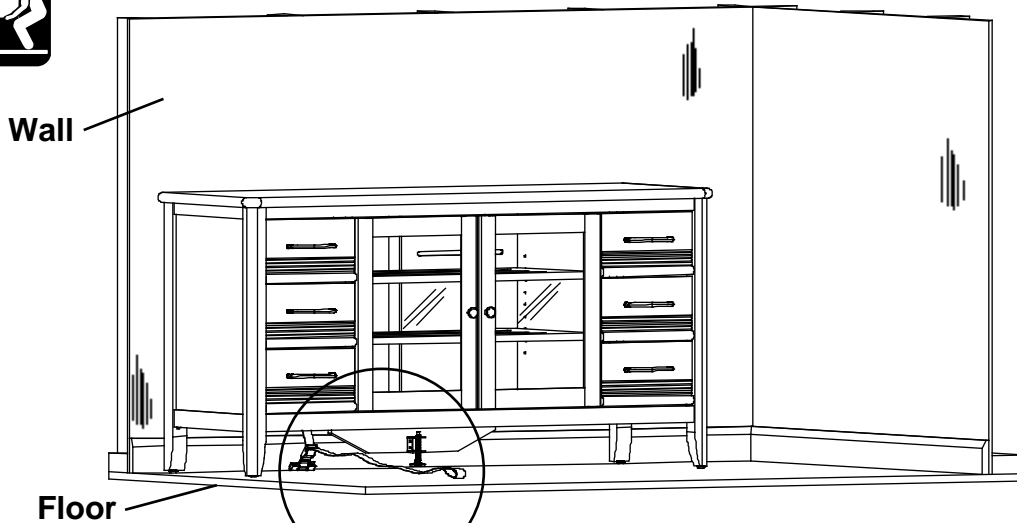
- Decide where you want to place the piece of furniture in your room. Mark the baseboard with a pencil mark directly behind the location where the tipping restraint is attached to your item. Move the item away from the wall far enough to allow you to access the spot where the baseboard meets the floor. Position the straps and Plastic Bracket (B) as shown in Figures 4 and 4a with the angled corners of the Plastic Bracket (B) firmly placed against the seam of the baseboard and floor. Attach by driving #8 x 3" Pan Head Screws (D) through the holes in the Plastic Bracket (B) into the seam below the baseboard where it meets the floor. See Figures 4 and 4a.



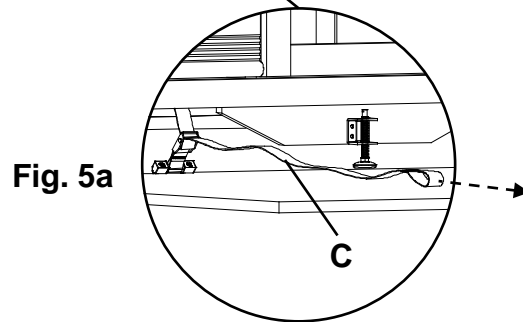
**2068GACH 2068CAFh 54"W McKenzie Media Console &  
2069GACH 2069CAFh 64"W McKenzie Media Console**  
*Assembly Instructions*

---

5. Move the item back into position against the wall and reach underneath the piece of furniture to grasp the loop in the free end of the strap. Pull the free end of the strap until portion between the Cam Buckle (A) and the back apron of the item is tight. See Figures 5 and 5a. If you need to move the piece of furniture reach beneath and locate the buckle which connects the two sections of the strap and depress the release lever, then pull on the section of strap that is between the buckle and the back apron of the furniture until there is enough slack to allow you to pull the item away from the wall.



**Fig. 5**



**Fig. 5a**