

Model #

# 2074AUFg 73"W McKenzie Center Channel Console

Assembly Instructions

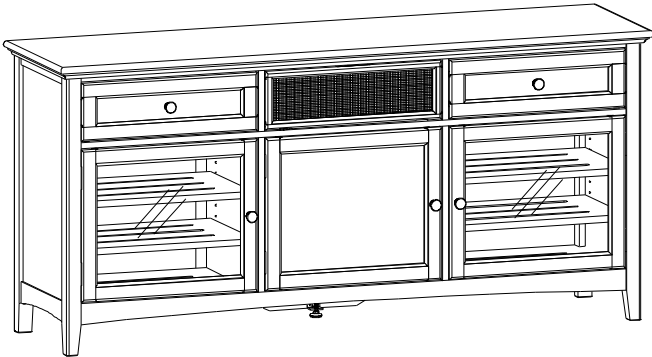

### Congratulations!

*This fine piece of furniture will make a gorgeous addition to your home. For the best results, read the Assembly Instructions and Finishing Hints before you begin your project.*

### IMPORTANT NOTES:

- For normal household use only. *Not* recommended for commercial use.
- Do not climb, sit or stand on this piece of furniture.
- Do not overload the drawers.
- Unload items before you move this unit.
- Before you load or move this unit, tighten all screws and supports.



- Handle the glass plates with care. Glass is fragile.
- Before you begin your project, completely read the Assembly Instructions and Finishing Hints.
- Store this item: 1- in its box; 2- in a dry place; 3- in temperatures that range from 40°F to 90°F (not on a cold and possibly damp cement floor).
- Periodically inspect your furniture for any loose glue joints, screws or any other problem that might affect the stability of your furniture. Tighten or repair as needed.
- This assembly requires two people.

### ! WARNING

Serious or fatal crushing injuries can occur from furniture tip-over. Use of tip-over restraints may only reduce but not eliminate the risk of tip-over.

#### To help prevent tip-over:

- Place heaviest items in the bottom drawers.
- Unless specifically designed to accommodate, do not set TVs or other heavy objects on top of this product.
- Never allow children to climb or hang on drawers, doors or shelves.
- Never open more than one drawer at a time.

**Warning:** At least one tipping restraint kit was included with your piece of Whittier Wood Furniture. When you receive your furniture, be sure to find and properly install the tipping restraint(s). If you cannot locate the restraint(s), please contact us immediately for replacement.

#### Notice to California Customers

California Prop 65 requires consumer goods to be labeled if any one of 850+ different chemicals or substances, including wood dust, is present even in trace amounts. Drilling, sawing, sanding or machining wood products generates wood dust, a substance known to the State of California to cause cancer. **Warning:** This product contains a chemical or substance known to the State of California to cause cancer, birth defects or other reproductive harm. *California Health and Safety Code Section 25249.6*

**DESIGN SUBJECT TO CHANGE WITHOUT NOTICE.**



**CALL US FIRST!** *Do not return this item to the store*

**Service Policy:** We will replace any part that is defective, missing or damaged during assembly. For a replacement part, directly contact Whittier Wood Products customer service department by phone, fax, mail or email.

**Hours:** Our friendly customer service staff can be reached Monday-Friday 7:00 a.m. to 5:00 p.m. (Pacific Time). You may leave a message 24 hours a day, seven days a week.

**To Order:** Provide the furniture model number (upper portion of this page), the part letter, production code, quantity needed, reason for replacement and your full name, address and telephone number.

*Parts ship from our Eugene, Oregon factory within one or two business days from the time we receive your request. Please allow five to ten business days for delivery.*

800-653-3336 • Outside the U.S. or Canada: 541-687-0213 • Fax: 541-687-2060  
www.whittierwood.com • P.O. Box 2827 • Eugene, Oregon 97402, U.S.A.



P.O. Box 2827  
Eugene, OR 97402 USA

Production Code:













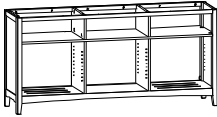

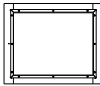
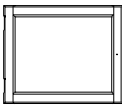
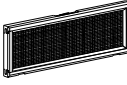
VN

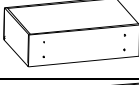
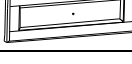
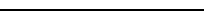
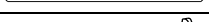
07/14







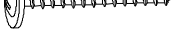













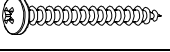

## 2074AUFg 73"W McKenzie Center Channel Console

### Parts List

Please identify the parts and check that quantities received match those on this list.  
If you need to replace a part, refer to the following letter and part name.

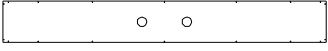
Part	Description		Quantity
A	Top Assembly (attached)		1
B	Adjustable Shelf		4
C	Center Adjustable Shelf		2
Dc	Case		1
E	Removable Back (installed)		2
F	Glass Door Frame (installed)		2
G	Center Door (installed)		1
Ha	Speaker Door (attached)		1
I	Door Glass (attached)		2
J	Drawer Box (inserted)		2
K	Drawer Face (installed)		2
L	Door Glass Support Rail (attached)		4
M	Door Glass Support Stile (attached)		4
N	Shelf Bracket (installed)		24
O	#6 x 1/2" Undercut Screw (inserted)		24
Q	Butler Hinge (attached)		2
R	Magnetic Push Lock (attached)		2
S	#5 x 5/8" Flat Head Screw (inserted)		12
V	Magnetic Catch (installed)		6
W	#6 x 5/8" Philtruss Screw (inserted)		42
X	Hinge (attached)		6
YA	#8 x 1-3/8" Lo-Profile Screw (inserted)		6

**2074AUFg 73"W McKenzie Center Channel Console**  
*Parts List*

<b>Part</b>	<b>Description</b>	<b>Quantity</b>
YC	Foot Bracket (attached) 	1
YD	Adjustable Glide (installed) 	1
YE	Tuscan Magnetic Plate (attached) 	8
YF	#6 x 5/8" Undercut Screw AB (inserted) 	52
YG	#8 x 7/8" Black Lo-Profile Screw (inserted) 	12
YH	#8 x 1-1/2" Machine Screw Tuscan (installed) 	5
YI	#10 x 3/4" Pan Head Screw (inserted) 	4
ZA	Drawer Slides (pre-installed sets) 	2
ZB	#6 x 3/4" Philtruss Screw (inserted) 	12
ZC	#6 x 1/2" Philtruss Screw (inserted) 	16
ZG	Small Adjustable Glide (installed) 	4
ZI	Knob (attached) 	5
ZK	Drawer Stop (attached) 	4
ZL	Turn Button (attached) 	8
ZM	#6 x 3/4" Flat Head Screw (inserted) 	30
ZN	#8 x 1-1/4" Pan Head Screw (inserted) 	24
ZP	#8 x 1-1/4" Black Screw (inserted) 	6
ZQ	#8 x 1-5/8" Black Screw (inserted) 	10
ZS	Flat Washer (inserted) 	2
ZT	Fitted Back (attached) 	1
ZU	Chain (attached) 	2
ZX	3mm x 12mm Pan Head Screw (inserted) 	4
ZY	Insert Nut (inserted) 	4
TS	Media Tipping Restraint (attached)	1 set

# 2074AUFg 73"W McKenzie Center Channel Console

## Assembly Instructions

Tool Required: Phillips Screwdriver, Pencil.



1. **DO NOT LEAN ON THE GLASS AT ANY TIME.**

To finish the Glass Door Frame (F), you must first remove the glass. Remove the door from its hinges and lay it face-down on a clean, protected surface. Remove the #6 x 3/4" Brass Flat Head Screws (ZM), the Door Glass Support Stiles (M), Door Glass Support Rails (L) and set aside. Carefully lift the Door Glass (I) and put it safely away. Finish the door frame, stiles and rails and, after the finish dries, replace the glass and attach the Door Glass Support Rails (L) and Door Glass Support Stiles (M) with #6 x 3/4" Brass Flat Head Screws (ZM). Repeat the step for the other door. Attach the doors to the base unit. See Figures 1, 1a and 1b.

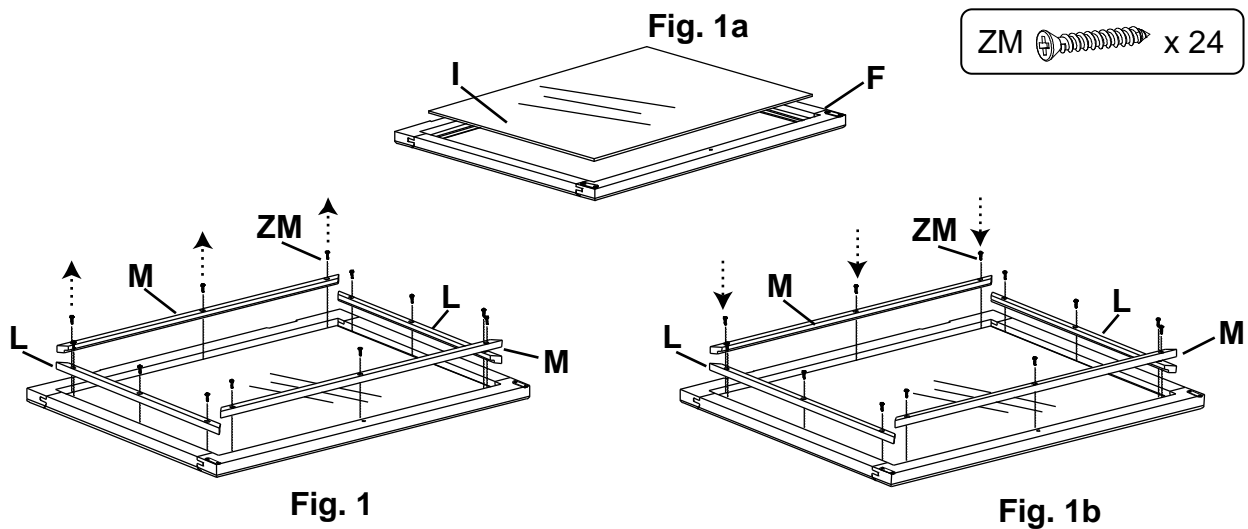

2. Remove the Speaker Door (Ha) and lay it face-down on a clean protected surface. Apply the finish. After the finish has dried, rehang the door.
3. Place the console at its final destination. Rotate the Adjustable Glides (ZG) found at the corners of the unit and (YD) at the bottom of the Center Foot until the unit is level. See Figure 3.

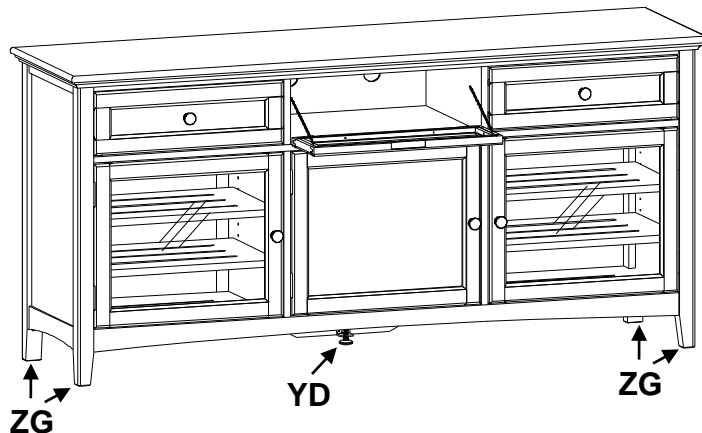

# 2074AUFg 73"W McKenzie Center Channel Console

## Assembly Instructions

4. To open the Speaker Door (Ha), press both corners until the magnets release. Gently grasp the finger groove in the top middle of the door and pull open. To shut the door, push gently but firmly on the Speaker Door until the Tuscan Magnetic Plates (YE) make secure contact with the Magnetic Push Locks (R). See Figure 4.

If you need to install your speaker from the back, remove the 18 #6 x 5/8" Philtruss Screws (W) and pull away the Fitted Back (ZT). After installing the component, replace the Fitted Back and attach with the 18 #6 x 5/8" Philtruss Screws (W).

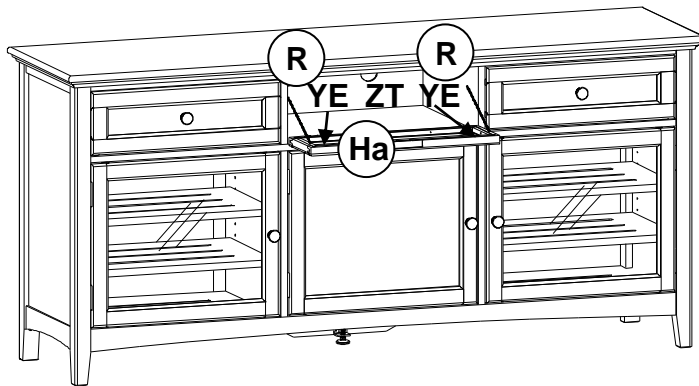

Fig. 4

5. To insert your media components and access wires more easily, you may want to remove the Removable Backs (E). To do so, unlock the Turn Buttons (ZL) as shown in Figures 5 and 5b. Slide the Backs away and place them off to the side. After installing the components, slide the Backs (E) behind the Drawer Stops (ZK) and lock the Turn Buttons. See Figures 5, 5a, 5b, 5c.

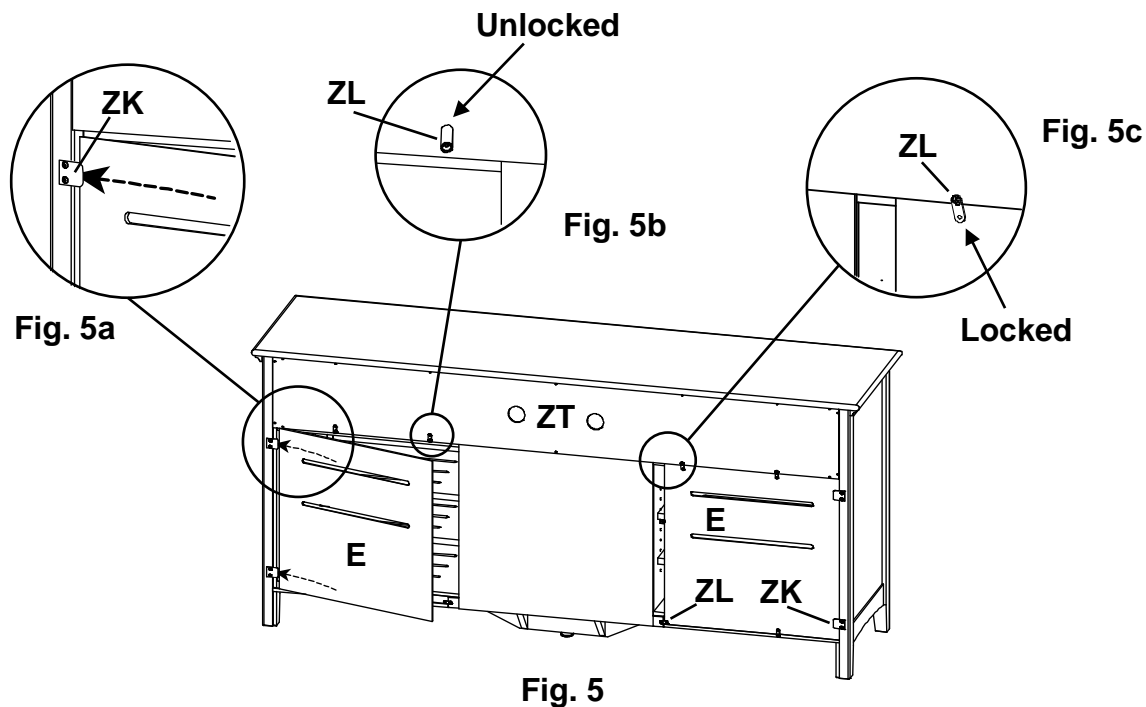

Fig. 5

# 2074AUFg 73"W McKenzie Center Channel Console

## Assembly Instructions

---

6. To move the Adjustable Shelves (B, C), remove the #6 x 1/2" Undercut Screws (O) and the Shelf (B, C). Insert the Shelf Brackets (N) into the desired slots, place the shelf on top of the brackets and insert the screws. See Figures 6 and 6a.



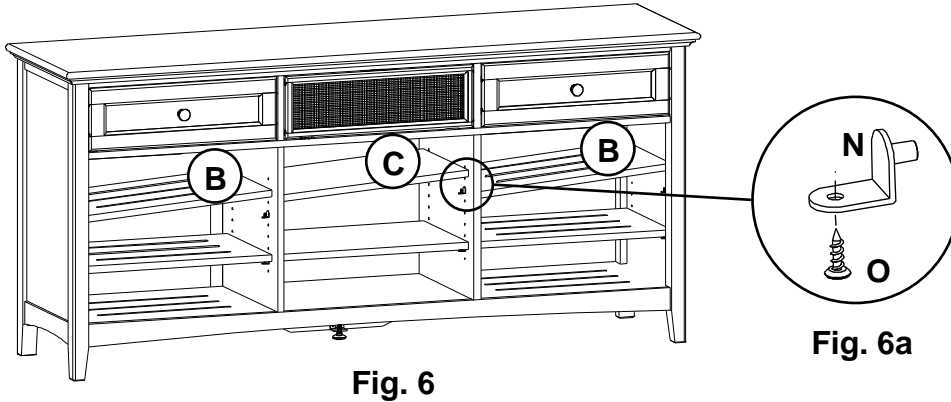

*Doors removed for illustration purposes.*

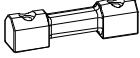

*Continued on Page 7*

## Furniture Tipping Restraint Instructions

Before you begin this assembly, identify each part and make sure the quantities received match what is on this list. If you need to replace a part, contact Whittier Wood Furniture customer service and refer to the following list for its name and letter code.

Part	Description		Quantity
A	Cam Buckle and Short Strap (installed)		1
B	Plastic Bracket (installed)		1
C	1" x 1000mm Long Strap (installed)		1
D	#8 x 3" Pan Head Screw		2
E	#10 x 1" Oval Head Screw (inserted)		1
F	Washer		1

**If you have a stone or tile floor or do not wish to drive screws into the corner of the baseboard and floor see the instruction included inside the tipping restraint kit for an alternate installation.**

- Decide where you want to place the piece of furniture in your room. Mark the baseboard with a pencil mark directly behind the location where the tipping restraint is attached to your item. Move the item away from the wall far enough to allow you to access the spot where the baseboard meets the floor. Position the straps and Plastic Bracket (B) as shown in Figures 7 and 7a with the angled corners of the Plastic Bracket (B) firmly placed against the seam of the baseboard and floor. Attach by driving #8 x 3" Pan Head Screws (D) through the holes in the Plastic Bracket (B) into the seam below the baseboard where it meets the floor. See Figures 7 and 7a.

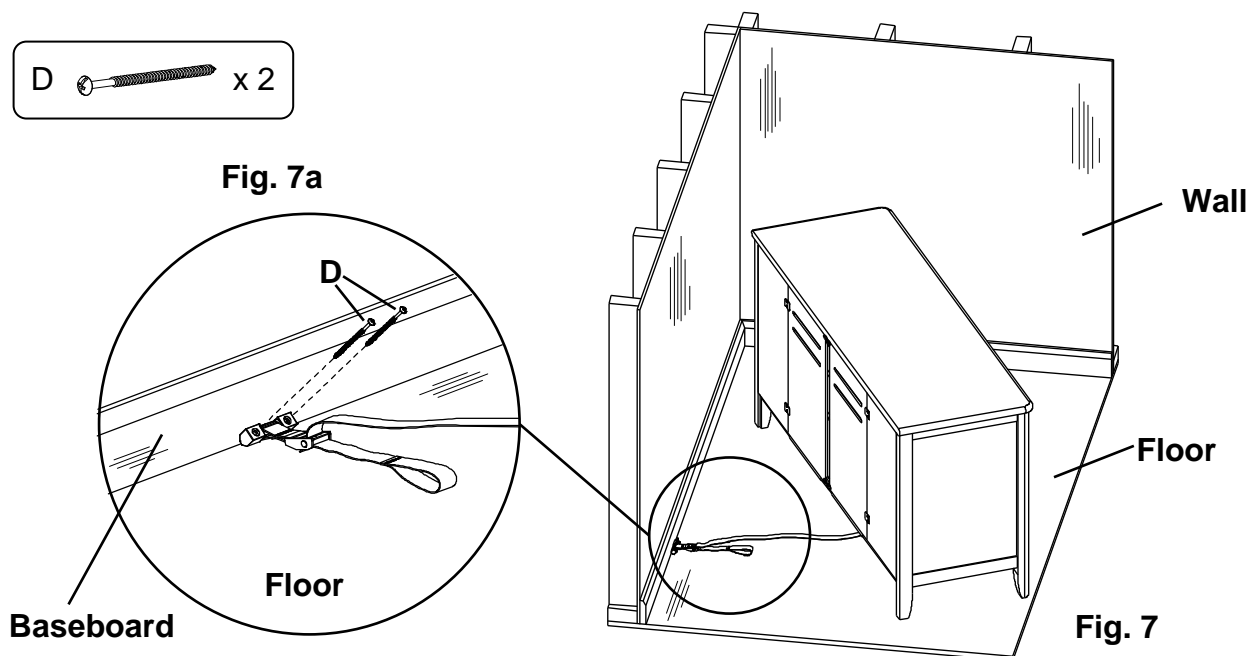

# 2074AUFg 73"W McKenzie Center Channel Console

## Assembly Instructions

8. Move the item back into position against the wall and reach underneath the piece of furniture to grasp the loop in the free end of the strap. Pull the free end of the strap until portion between the Cam Buckle (A) and the back apron of the item is tight. See Figures 8 and 8a. If you need to move the piece of furniture reach beneath and locate the buckle which connects the two sections of the strap and depress the release lever, then pull on the section of strap that is between the buckle and the back apron of the furniture until there is enough slack to allow you to pull the item away from the wall.

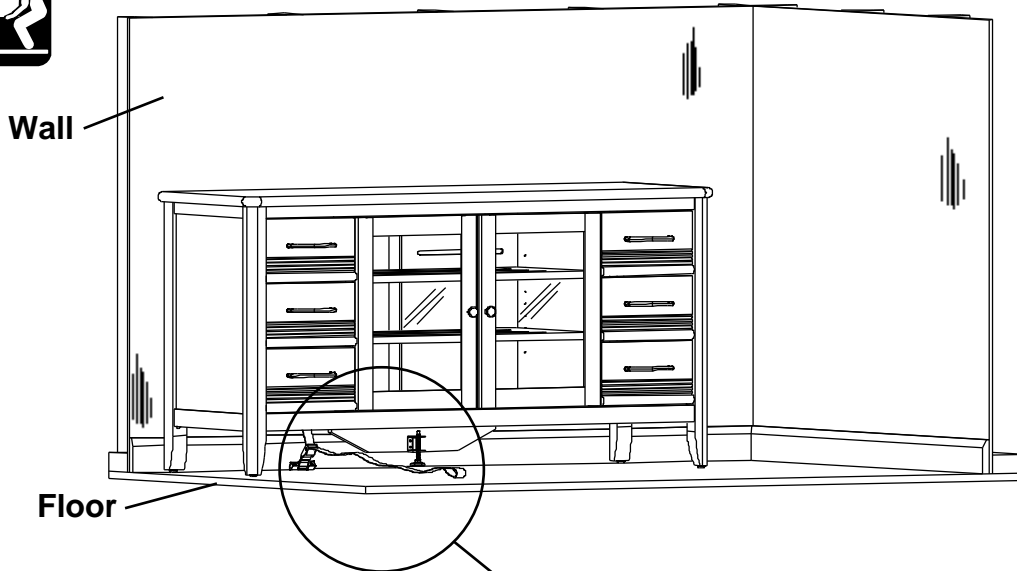

Fig. 8

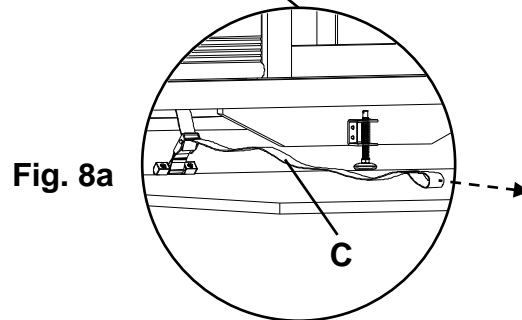

Fig. 8a



# Whittier Finishing Hints

## Checklist of materials

- |   |  |  |
|---|--|--|
| <input type="checkbox"/> Rubber gloves  | <input type="checkbox"/> Tack cloth                            | <input type="checkbox"/> #220 & #320 sandpaper |
| <input type="checkbox"/> Lint-free rags | <input type="checkbox"/> Drop cloth                            | <input type="checkbox"/> Painter's tape        |
| <input type="checkbox"/> Paper towels   | <input type="checkbox"/> Stain brushes (poly bristle and foam) | <input type="checkbox"/> Wood glue             |
| <input type="checkbox"/> Cotton swabs   |  | <input type="checkbox"/> Dust mask             |

**CAUTION:** If you have environmental or chemical sensitivities, please take the necessary precautions and use personal protective equipment to aid in limiting your exposure. Personal protective equipment may include but are not limited to gloves, dust masks or respirators.

**NOTICE TO CALIFORNIA CUSTOMERS:** California Prop 65 requires consumer goods to be labeled if any one of 850+ different chemicals or substances, including wood dust, is present, even in trace amounts. Drilling, sawing, sanding or machining wood products generates wood dust, a substance known to the State of California to cause cancer. **Warning:** This product contains a chemical or substance known to the State of California to cause cancer, birth defects or other reproductive harm. California Health and Safety Code Section 25249.6

## Getting started

*Assembly Instructions may contain special finishing information or gluing requirements for that item.*

Completely read both the Assembly Instructions and these Finishing Hints before you begin your project.

**Choosing the finish:** Ask your retailer for advice on how to finish bare wood. Choose a finish that meets your expectations for the end use of the product. Will you use it as a work surface as on a desk or kitchen island? Are you matching a finish on existing furniture? The answers to these questions may affect the type of finish you choose.

**Where to work:** Choose an area that has good light and is well ventilated, warm and dry. If the work area is cold and damp, the wood finishing products may require a longer drying time than the labels indicate. Do not work in a dirty or dusty area – dirt and/or dust can embed in the finish.

## Gluing hints

These are general hints. Refer to the Assembly Instructions for detailed information on how to glue your specific product. Use wood glue such as Elmer's Wood Glue, Titebond Wood Glue or the equivalent. Some

instructions call for a slow drying glue. Carefully read the label and instructions of the glue manufacturer. Your unit may not need glue.

1. We strongly recommend that you lay out all the parts and familiarize yourself with how they fit together before assembling with glue. Glue will set up quickly. You can damage parts if you try to reposition any that have been assembled incorrectly.
2. For glue to properly bond, it is very important to apply the wood glue to bare wood. Protect your eyes and blow into holes to clear excess dust. This will help the glue to adhere to a clean surface.
3. If you plan on finishing the product before you assemble it, place painter's tape three-fourths of the way up from the end of a dowel, spindle or tenon. This protects the ends from the finishing product but allows finish application where it will be visible. Finishing products inhibit the bonding properties of wood glue. Remove the tape prior to the final assembly.
4. Avoid getting glue on surfaces to be finished. Most stains or finishes will not penetrate where glue has been spilled. Wet glue can be wiped off with a damp cloth. Follow with a light sanding of the area to ensure a proper finish.
5. It is important to apply an even coat inside holes and slots. Use a small dowel, pencil or cotton swab to spread glue evenly around the inside of the holes. Do not over glue. The tight fit of the spindles or dowels in the holes can cause glue to be pushed to the bottom of the hole. If too much glue is used it will fill the holes and not allow the spindle or dowel to be fully inserted.
6. Glue usually takes several hours to cure or harden but it will set up or grab in several seconds. Once you begin final assembly, proceed quickly.

## Finishing hints

1. Use products of the same brand to ensure compatibility. It is not recommended to mix solvent based and water based finishes. *Always read and follow all label directions on the can.*
2. Alder is a porous hardwood and often looks best when following the finishing instructions for softwoods.
3. Use a wood conditioner under oil base stains.



P.O. Box 2827  
Eugene, OR 97402 USA  
Toll Free: 800-653-3336  
Ph: 541-687-0213  
Fax: 541-687-2060  
www.whittierwood.com

## Preparing the surface

1. Sand each piece with #220 grit sandpaper. Sand with the grain of the wood on flat surfaces and opposite the grain on turnings. Some parts may be plywood. Be careful not to sand through the veneer. End grain such as table top ends, seat edges and grooves on turnings accept more stain. Extra sanding in these areas with #320 grit sandpaper reduces stain absorption and creates a more evenly stained piece.
2. When sanding is completed, wipe the surface of your furniture with a lint-free rag or tack cloth. Make sure the item is free of dust before you proceed.

## Staining

1. *Always read and follow all label directions.* Stir the stain well before you start. Stir periodically throughout the duration of the project to maintain uniform color consistency.
2. Test stain on an inconspicuous spot on your project. Put at least one coat of your top coat over the test area as it also affects the look of the stain. *Test every type of wood that is in your kit. These are identified in the Assembly Instructions.* Different types of wood may react differently to the stain color. You might need to add a second coat of stain to lighter woods to match the darker woods in your kit.
3. Apply stain with a poly brush or lint-free cloth. Apply stain over a small area and wipe off excess. Working in small areas will make the color easier to control.
4. Cotton swabs are ideal for hard to reach areas.
5. Allow the stain to dry thoroughly before you proceed.

## Applying the top coat

1. *Always read and follow all label directions.* Stir your top coat gently; do not shake. Shaking the can creates bubbles that are hard to remove.
2. All surfaces including the underside of table tops and inside drawers must be sealed with at least one layer of a top coat. This will help minimize wood swelling, shrinkage, warping and cupping due to changes in moisture content or temperature.
3. Apply a minimum of two coats when you use polyurethane or varnish (especially on all table top and work surfaces). After allowing the first coat to dry, sand lightly with #320 grit sandpaper. Remove dust with a lint-free rag or tack cloth. For added protection,

apply additional coats. Lightly sand and wipe surface with a lint-free rag or tack cloth between coats.

4. Some finishes tend to slightly raise the grain. This can be easily controlled with a light sanding between coats. Do not use steel wool when you use water-based finishes. Strands of steel fiber caught in the wood can cause rust spots when coated with any water-based product.

## Painting

1. *Always read and follow all label directions.* Since there is a large variation between paint manufacturers and products, ask your paint supplier for specific advice on how to best use the paint you purchase. Ask them specifically for advice on finishing bare wood.
2. First coat the wood with a primer. An oil based primer works best for a smooth finish. If you do not wish to use a solvent based primer, water based primer works almost as well. However it may raise the wood grain and require additional sanding.
3. Buy quality brand paint in a satin, semi-gloss, or gloss sheen. Apply a second coat for a smooth finish. Lightly sand between coats using with #320 grit sandpaper so that the second coat will bond well. Be sure to use a tack cloth after sanding to remove any residue. Repeat as desired.
4. No top coat is required when using paint.