

Model #

# 2101GBCH

## Cascade 3-Drawer Media Chest

*Glazed Black Cherry finish*

*Assembly Instructions*



### **Congratulations!**

*This fine piece of furniture will make a gorgeous addition to your home. For the best results, read the Assembly Instructions before you begin your project.*

## **! WARNING**

**Serious or fatal injuries can occur from furniture tip-over. To help prevent tip-over:**

- Place heaviest items in the bottom drawers.
- Unless specifically designed to accommodate, do not set a TV or any other heavy object on top of this product.
- Never allow children to climb or hang on drawers, doors or shelves.
- Never open more than one drawer at a time.

**Properly installing tipping restraints can reduce but does not eliminate the risk of tip-over.**

### **! IMPORTANT NOTES:**

- For normal household use only. **Not** recommended for commercial use.
- Before you begin your project, completely read the Assembly Instructions.
- Before you load or move this unit, tighten all screws and supports.
- Unload items before you move this unit.
- Store this item: 1- in its box; 2- in a dry place; 3- in temperatures that range from 40°F to 90°F (not on a cold and possibly damp cement floor).
- Periodically inspect your furniture for any loose glue joints, screws or any other problem that might affect the stability of your furniture. Tighten or repair as needed.

**DESIGN SUBJECT TO CHANGE WITHOUT NOTICE.**



**CALL US FIRST! Do not return this item to the store.**

**Service Policy:** We will replace any part that is defective, missing or damaged during assembly. For a replacement part, please phone, fax, mail or email Whittier Wood Products customer service department.

**Hours:** You can reach our friendly customer service staff Monday-Friday 7:00 a.m. to 5:00 p.m. (Pacific Time). You may leave a message 24 hours a day, seven days a week.

**To Order:** Provide the finish and furniture model number ((upper portion of this page), the part letter, production code, quantity, reason for replacement and your full name, address and telephone number.

*Parts ship from our Eugene, Oregon factory within one or two business days from the time we receive your request. Please allow five to ten business days for delivery.*

**800-653-3336** • Outside the U.S. or Canada: 541-687-0213 • Fax: 541-687-2060  
www.whittierwood.com • P.O. Box 2827 • Eugene, Oregon 97402, U.S.A.

**Whittier  
Wood**  
FURNITURE

P.O. Box 2827  
Eugene, OR 97402 USA















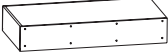
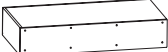
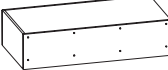







Production Code:

VN

07/11

# 2101GBCH Cascade 3-Drawer Media Chest – Parts List

Please identify the parts and check that quantities received match what is on this list.  
If you need to replace a part, refer to the following letter and item name.

Part	Description	Quantity
A	Top Assembly 	1
B	Case 	1
C	Removable Back 	1
D	Lower Back 	1
E	Cleat 	2
F	Small Drawer Box (inserted) 	1
G	Medium Drawer Box (inserted) 	1
H	Large Drawer Box (inserted) 	1
I	Small Drawer Face (installed) 	1
J	Medium Drawer Face (installed) 	1
K	Large Drawer Face (installed) 	1
L	Drawer Slides (installed) 	3 sets
M	#6 x 1/2" Philtruss Screw (inserted) 	18
N	#6 x 3/4" Philtruss Screw (inserted) 	18
O	#8 x 7/8" Lo-Profile Screw (inserted) 	24
P	#8 x 1-1/4" Pan Head Screw (inserted) 	12
Q	#8 x 1" Pan Head Screw (inserted) 	8
R	#8 x 1-1/4" Black Screw (inserted) 	6
S	Small Pull (attached) 	6
T	#8 x 1-1/4" Machine Screw (installed) 	12
U	T-Nut (inserted) 	4
V	Small Adjustable Glide (installed) 	4
W	Drawer Stop (attached) 	3
X	Turn Button (attached) 	3
Y	#6 x 5/8" Philtruss Screw (inserted) 	9
TR	Furniture Tipping Restraint	2

# 2101GBCH Cascade 3-Drawer Media Chest – Parts List

Tool Required: Phillips Screwdriver

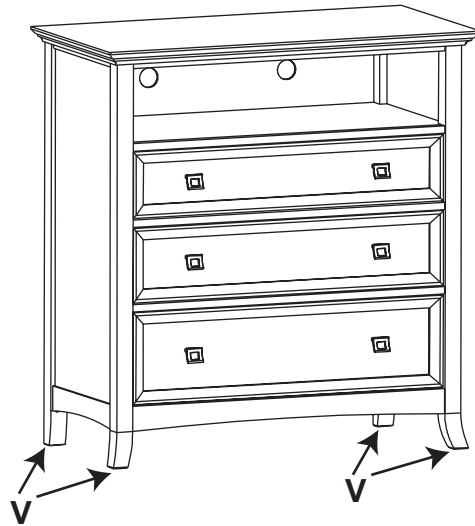
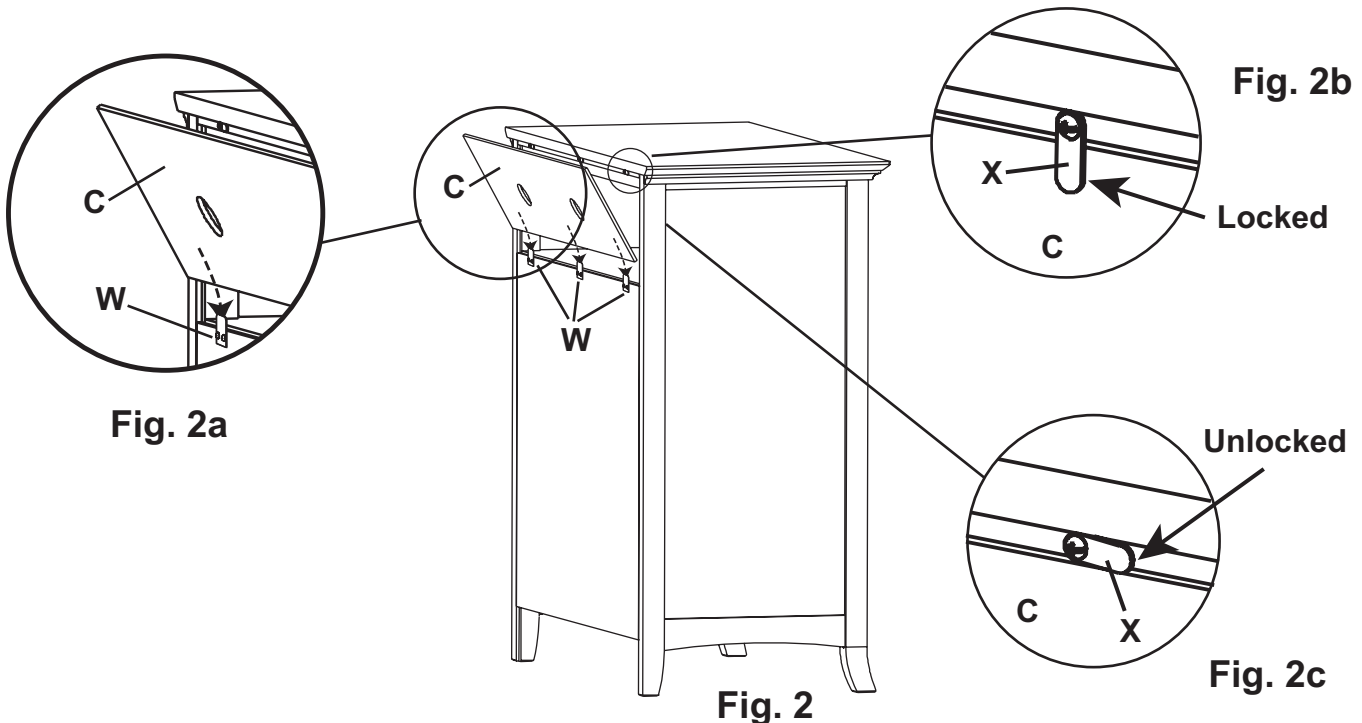
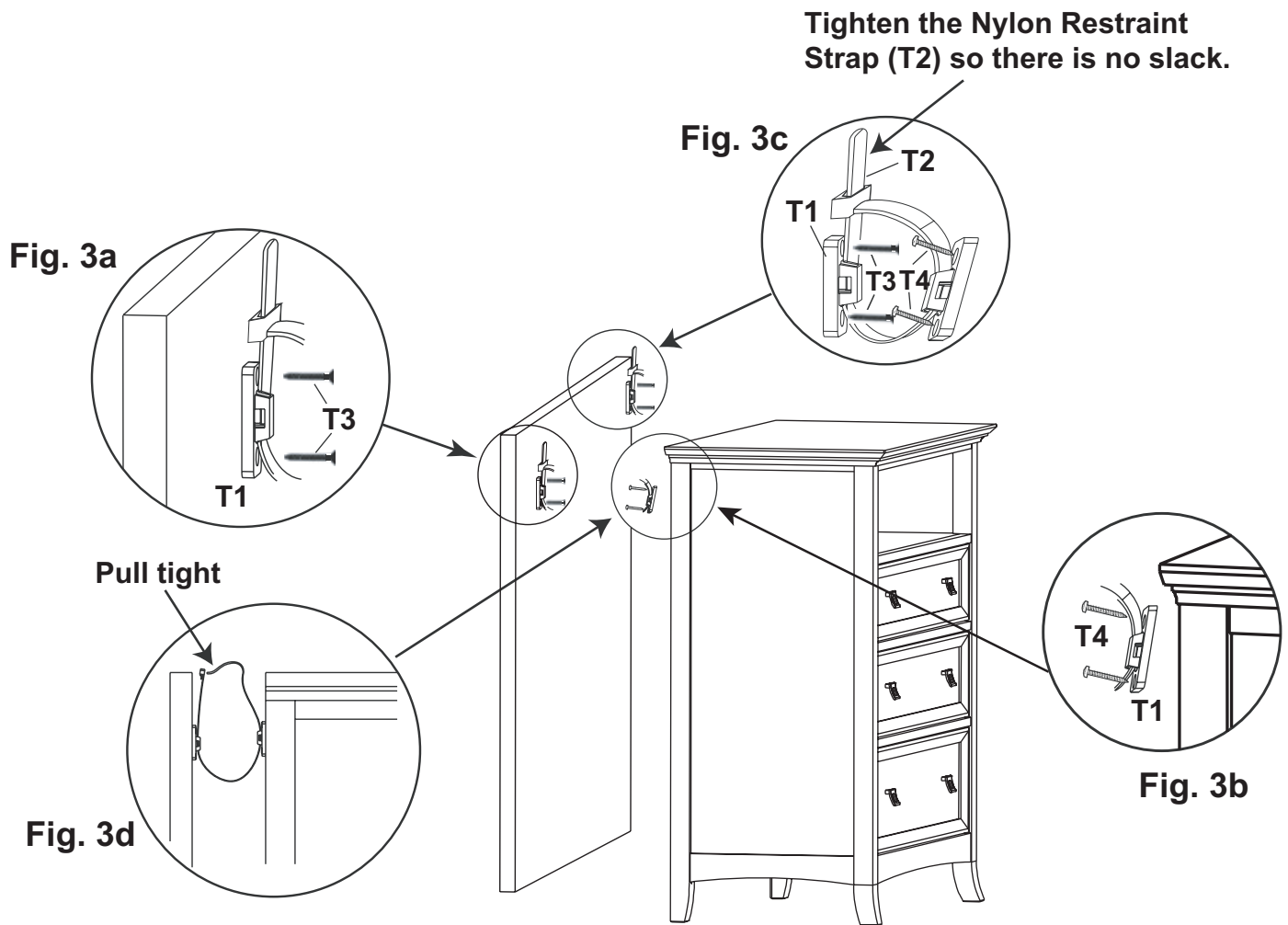

Fig. 1

1. Place the unit at its final destination. Rotate the Small Adjustable Glides (V) on the bottoms of the legs until the unit is level. See Figure 1.



2. To insert your media components and access wires easily, detach the Removable Back (C). To do so, unlock the Turn Buttons (W) as shown in Figures 2b and 2c. Slide the Back away and place it off to the side. See Figure 2a. To put it back into place, slide the Back and position the Turn Buttons so that they are locked. See Figures 2, 2a and 2b.



### Tipping restraint:

3. Locate two studs in the wall behind the unit. Attach a Clip (T1) to one wall stud with two #8 x 2" Black Screws (T3). See Figure 3a. Attach a second clip to the unit with two #8 x 1" Pan Head Screws (T4). See Figure 3b. Connect the two clips with the Nylon Restraint Strap (T2). **Pull the Nylon Restraint Strap (T2) tight so there is no slack.** See Figures 3c and 3d. Repeat this procedure to attach the second tipping restraint. If you cannot locate two studs, purchase the proper wall attachment hardware for your type of wall and secure the unit.