

Model #

2407GAC

2407CAF

McKenzie

Writing Desk

GAC = Glazed Antique Cherry finish

CAF = Caffè finish

Assembly Instructions

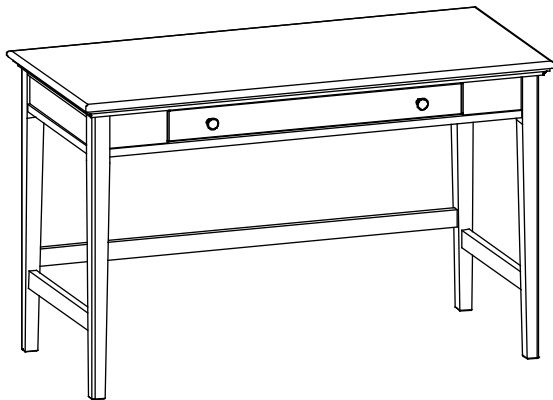

Thank you for allowing us to help you furnish your home. We are certain you will be delighted with your new furniture for many years to come.

IMPORTANT NOTES:

- For normal household use only. *Not* recommended for commercial use.
- Do not climb, sit or stand on this piece of furniture.
- Use a protective pad when you use the top of this piece as a writing surface.
- Do not overload the drawer.
- Unload items before you move this unit.

WARNING

Drilling, sawing, sanding or machining wood products can expose you to wood dust, a substance known to the state of California to cause cancer. Avoid inhaling wood dust or use a dust mask or other safeguards for personal protection.

For more information go to: www.p65warnings.ca.gov/wood

This product can expose you to chemicals, including formaldehyde, which are known to the State of California to cause cancer.

For more information go to: www.p65warnings.ca.gov/furniture

DESIGN SUBJECT TO CHANGE WITHOUT NOTICE.

CUSTOMER SERVICE

If you ever have questions about your furniture, please do not hesitate to contact us. In the unlikely event you need a replacement part; we can make those parts available through an authorized Whittier Wood Furniture dealer. If you cannot order replacement parts through your dealer, please contact our customer service department.

Hours: Our friendly customer service staff can be reached:

Monday-Friday 8:00 a.m. to 5:00 p.m. (Pacific Time).

You may leave a message 24 hours a day, seven days a week.

Customer Service: 800-653-3336 • Outside the U.S.: 541-687-0213

Fax: 541-687-2060 • Email: info@whittierwood.com

**Whittier
Wood**

FURNITURE

P.O. Box 2827
Eugene, OR 97402 USA

Production Code:











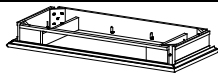

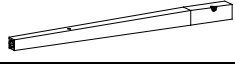
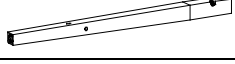
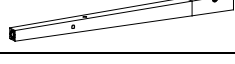
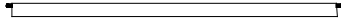
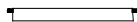

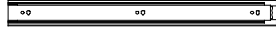



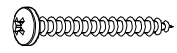



VN

11/17

2407GAC 2407CAF McKenzie Writing Desk

Parts List

Please identify the parts and check that quantities received match those on this list.
If you need to replace a part, refer to the following letter and part name.

Part	Description		Quantity
A	Top Assembly		1
B	Left Front Leg		1
C	Right Front Leg		1
D	Left Back Leg		1
E	Right Back Leg		1
F	Back Stretcher		1
G	Side Stretcher		2
H	Keyboard Tray Box (inserted)		1
I	Keyboard Tray Face (installed)		1
J	16" Drawer Slides (pre-installed set)		1
K	#6 x 3/4" Philtruss Screw (inserted)		6
L	#6 x 1/2" Undercut Screw (inserted)		8
M	#6 x 1/2" Philtruss Screw (inserted)		6
N	#8 x 1-1/4" Pan Head Screw		40 (34 inserted)
O	#8 x 1-1/4" Black Screw (inserted)		13
P	#8 x 1-5/8" Machine Screw Tuscan (installed)		2
Q	Left Keyboard Hinge (attached)		1
R	Right Keyboard Hinge (attached)		1
S	5/16" Flat Washer		4
T	#8 Washer (inserted)		18
U	3/8" x 1" Insert Nut (inserted)		4
V	3/8" x 2-1/2" Hex Bolt		4
W	1/4" x 20mm Insert Nut (inserted)		4
X	Wood Dowel (inserted)		6
Y	Roller Catch Kit (pre-installed set)		1
ZA	Knob (attached)		2
ZB	Adjustable Glide (installed)		4

2407GAC 2407CAF McKenzie Writing Desk

Assembly Instructions

Tools Required: Phillips Screwdriver, 9/16" or Adjustable Wrench, Mallet or Padded Hammer.

1. Position the Legs (B, C, D and E) and Side Stretchers (G) as shown in Figure 1. **NOTE: Be sure the insert holes on the top corners of the legs face inward and the pocket drilled holes of the Side Stretchers face the bottom of the legs.** Using the dowel holes as guides, insert the dowels of the Side Stretchers (G) into the holes in the Legs.

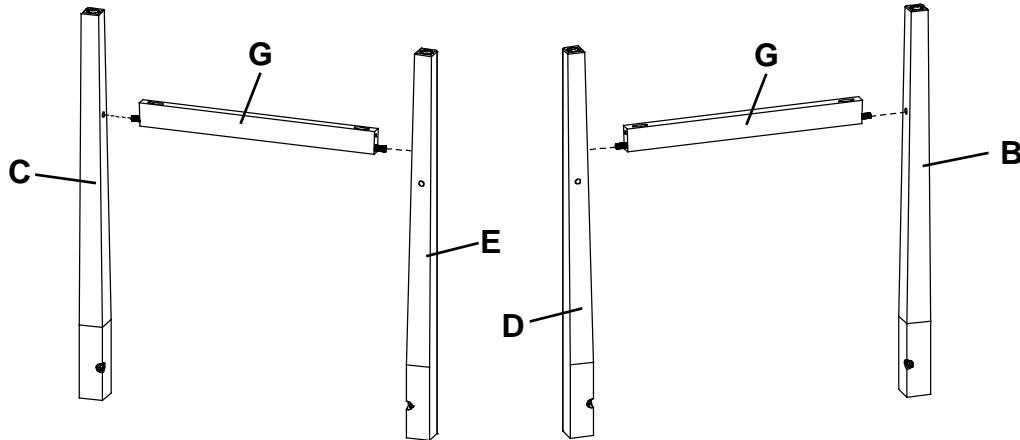

Fig. 1

2. Insert the Back Stretcher (F) into the Back Legs (D & E) as shown in Figure 2. Place the Top Assembly (A) upside-down on a clean, protected surface. Position the leg/stretcher assembly at the corners of the Top Assembly (A). Insert the 3/8" x 2-1/2" Hex Bolts (V) with the Washers (S) through the corner brace into the Legs and securely fasten. See Figure 2a.

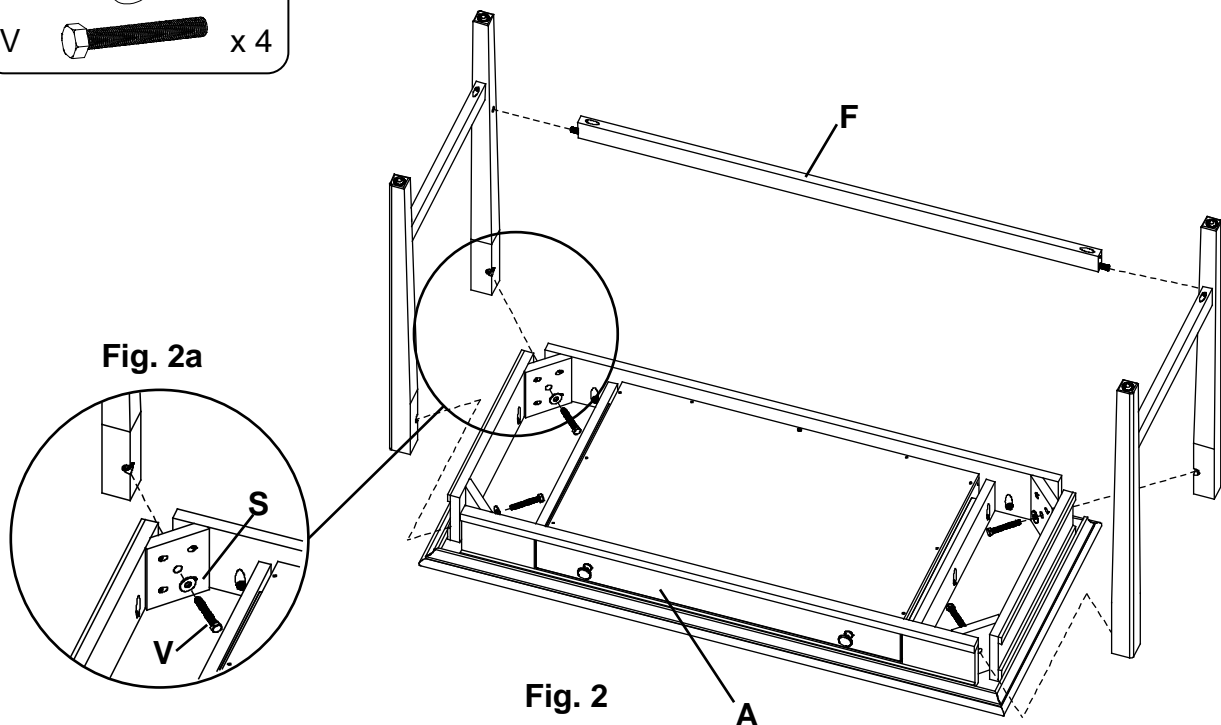
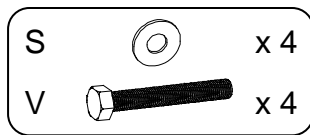
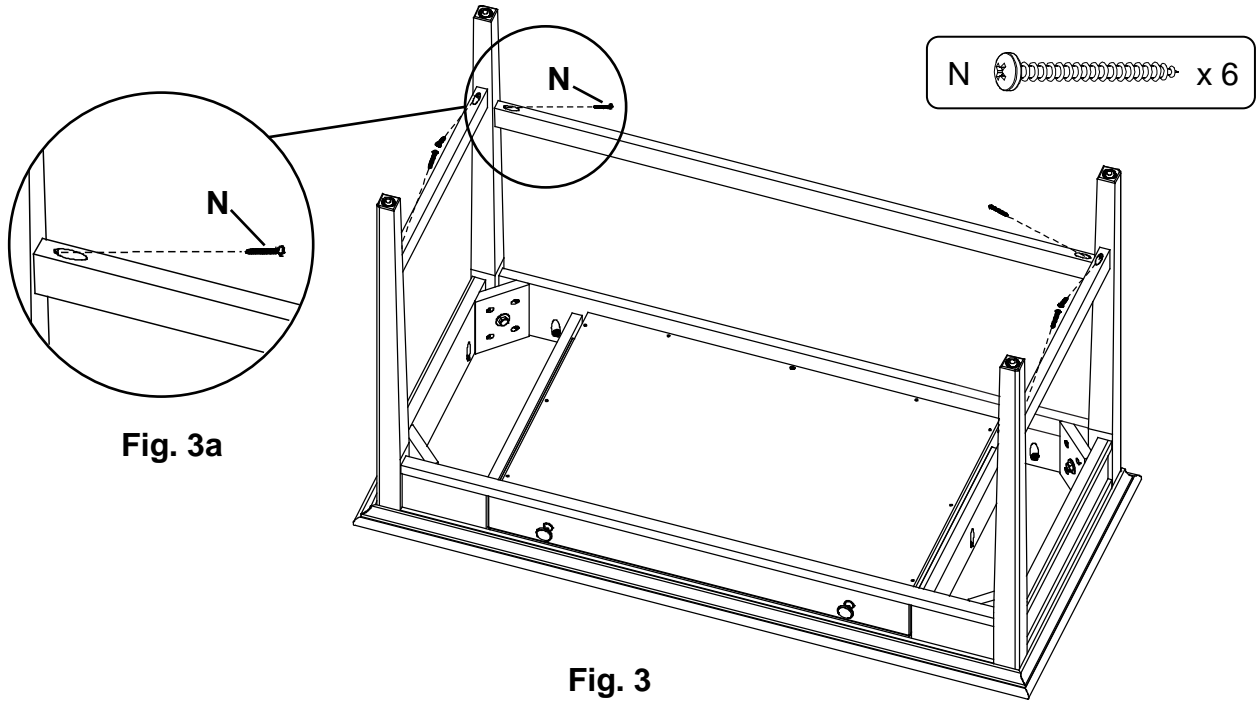

Fig. 2

2407GAC 2407CAF McKenzie Writing Desk

Assembly Instructions

- Using the pocket drilled holes as a guides, secure the stretchers to the legs with six #8 x 1-3/4" Pan Head Screws (N). See Figures 3 and 3a.



- Turn the table upright.

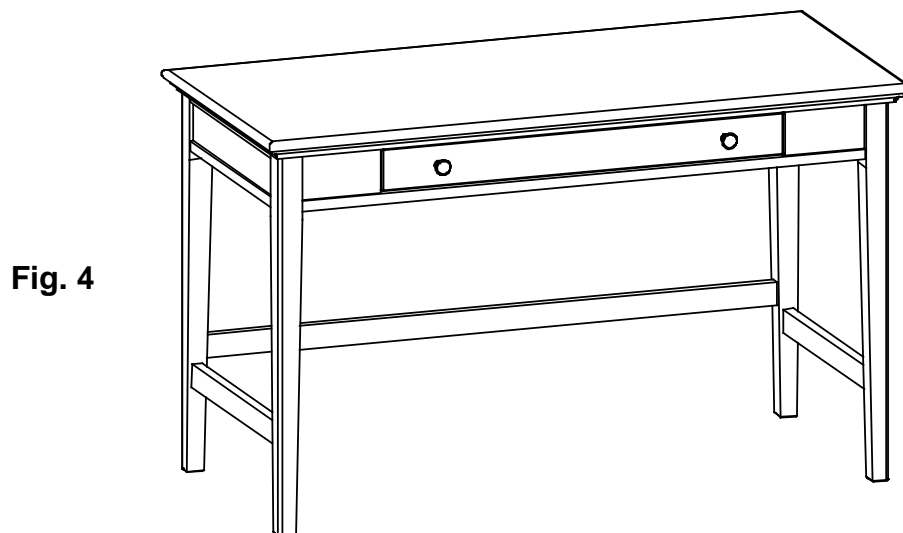

2407GAC 2407CAF McKenzie Writing Desk

Assembly Instructions

- The drawer (H) can be used as a keyboard tray or utility drawer. To use it as a keyboard tray, open the drawer and pull down on the front. This unlocks the roller catches. To lock it back into place, push up on the drawer front. See Figure 5.
The shortened drawer back allows easy cord access.

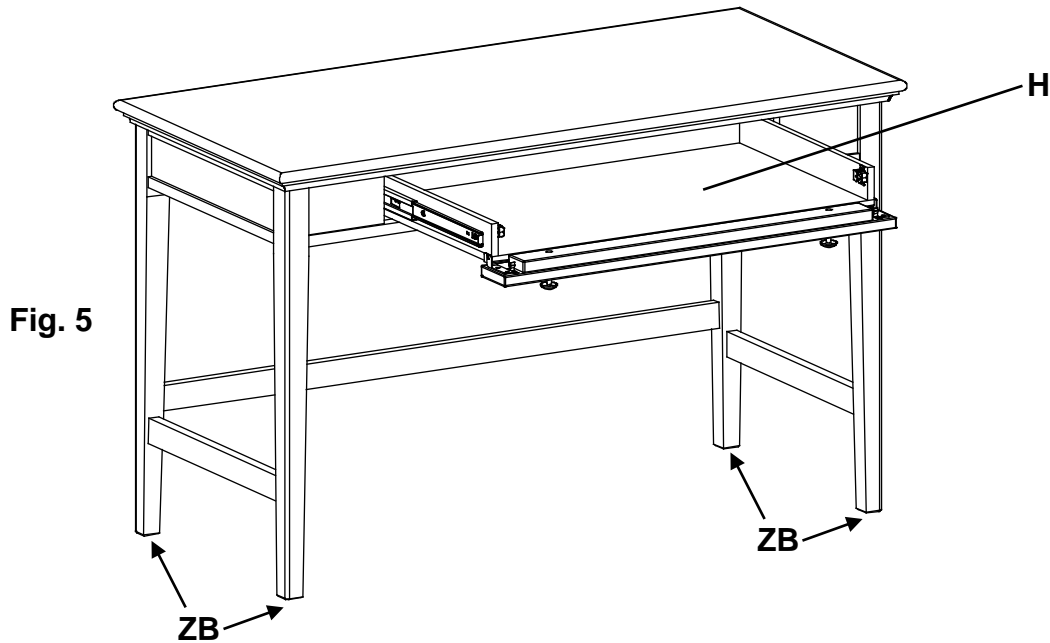

- Place the desk at its final destination. To level the unit, rotate the Adjustable Glides (ZB) found on the bottoms of the legs. See Figure 5.
- Use a protective pad when you use the top of this piece as a writing surface.