

Model #

# 2657AUF McKenzie Buffet

Assembly Instructions

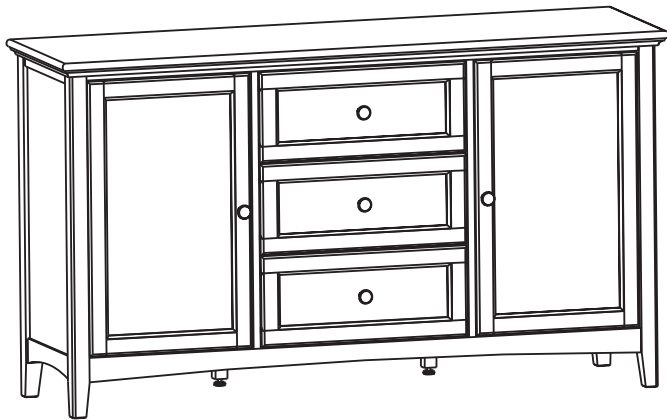

## Congratulations!

*This fine piece of furniture will make a handsome addition to your home. For the best results, start by reading the Assembly Instructions and Finishing Hints **before** you begin your project.*

**For normal household use only.  
NOT recommended for commercial use.**



**Unload items from this unit prior to moving.**

**Before loading or moving this unit, check all screws and supports for tightness.**

**Do not overload drawers or shelves in this unit.**

**Do not sit, stand or climb on this piece of furniture.**

**DESIGN SUBJECT TO CHANGE WITHOUT NOTICE.**

**Whittier  
Wood**  
FURNITURE

P.O. Box 2827  
Eugene, OR 97402 USA



**CALL US FIRST!**  
**DO NOT RETURN ITEM TO STORE**

**Service Policy:** We will replace parts which are defective, missing or damaged. Please contact Whittier Wood Products customer service department directly (by phone, fax, mail or E-mail) for replacement parts.

**Hours:** Our friendly customer service staff can be reached Monday-Friday 7:00 a.m. to 5:00 p.m. (Pacific Time). A message can be left 24 hours a day, 7 days a week.

**To Order:** Provide the complete furniture model number, part letter, production code, quantity needed, reason for replacement and your full name and address along with a telephone number in case we need to contact you.

*Parts ship from our Eugene, Oregon factory within 1 or 2 business days from the time we receive the request. Please allow 5-10 business days for delivery.*

**800-653-3336**

Outside U.S. or Canada: 541-687-0213

Fax: 541-687-2060 • [www.whittierwood.com](http://www.whittierwood.com)

Mail: P.O. Box 2827 • Eugene, Oregon 97402, U.S.A

## IMPORTANT NOTES:

- Read the Assembly Instructions and Finishing Hints completely before beginning your project.
- Store the item: 1) in the box; 2) in a dry place; 3) temperatures ranging from 40° to 90°. (Not on a cold, possibly damp, cement floor.)
- Inspect your furniture periodically for any loose glue joints or screws, or any other problem which may affect the stability of your furniture. Tighten or repair as needed.
- This Assembly requires two people.

Production Code:

VN

08/08

# 2657AUF McKenzie Buffet — Parts List

Please identify the parts and check that quantities received match those on this list.

If you need to replace a part, refer to the following letter and model name.



A — 2657 Top Assembly  
— Qty. 1 (Attached)

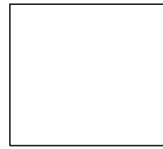

B — Adjustable Shelf — Qty. 4

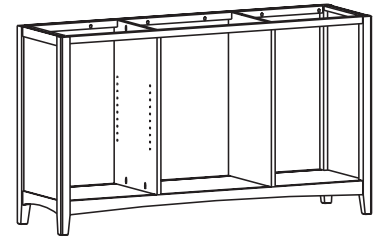

C — 2657 Case Only — Qty. 1

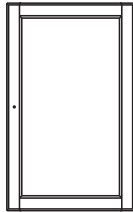

D — Door — Qty. 2 (Installed)

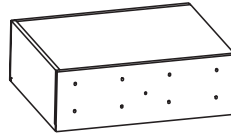

E — Drawer Box  
— Qty. 3 (Installed)

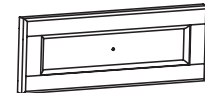

F — Drawer Face  
— Qty. 3 (Installed)



G — Drawer Slides  
— Qty. 3 sets (Installed)



H — Knob  
— Qty. 5 (Installed)



I — #8 x 1½" Machine Screw  
— Qty. 5 (Installed)



J — Shelf Bracket  
— Qty. 16 (Attached)



K — #6 x ½" Undercut Screw  
— Qty. 52 (Inserted)

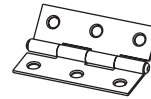

L — Hinge — Qty. 4  
(Installed)



M — #6 x ¾" Brass Flat  
Head Screw — Qty. 24  
(inserted)

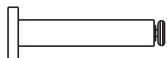

R — Assembled Foot  
— Qty. 2 (Attached)



S — T-Nut  
— Qty. 6 (Inserted)



T — Adjustable Glide  
— Qty. 2 (Installed)



U — Adjustable Glide  
— Qty. 4 (Installed)



N — Clip — Qty. 4



O — Nylon Restraint Strap  
— Qty. 2



P — #8 x 2" Black Screw  
— Qty. 4



Q — #8 x 1" Pan Screw  
— Qty. 4

# 2657AUF McKenzie Buffet Assembly Instructions

TOOL REQUIRED: Phillips Screwdriver



1. Rotate the Adjustable Glides found at the bottoms of the Assembled Foot (R) until the unit is level.

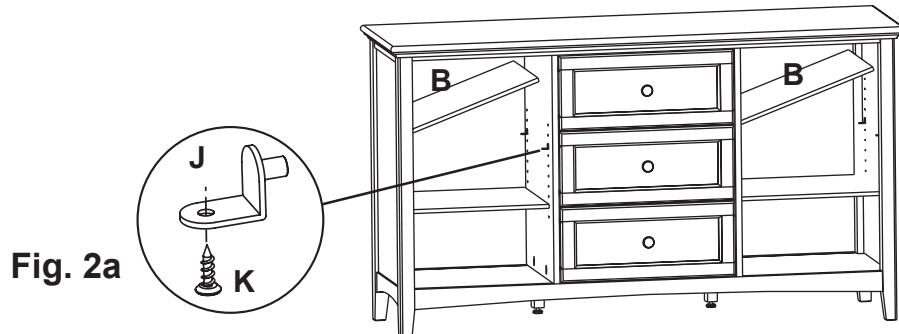

**Fig. 2**

*Doors removed for purposes of this illustration.*

2. Install the Adjustable Shelves (B) at the desired location using the Shelf Brackets (J). See Figure 2. Attach the shelves to the shelf brackets by inserting #6 x 1/2" Undercut Screws (K) through the bottom of the shelf bracket and into the shelf. See Figure 2a.

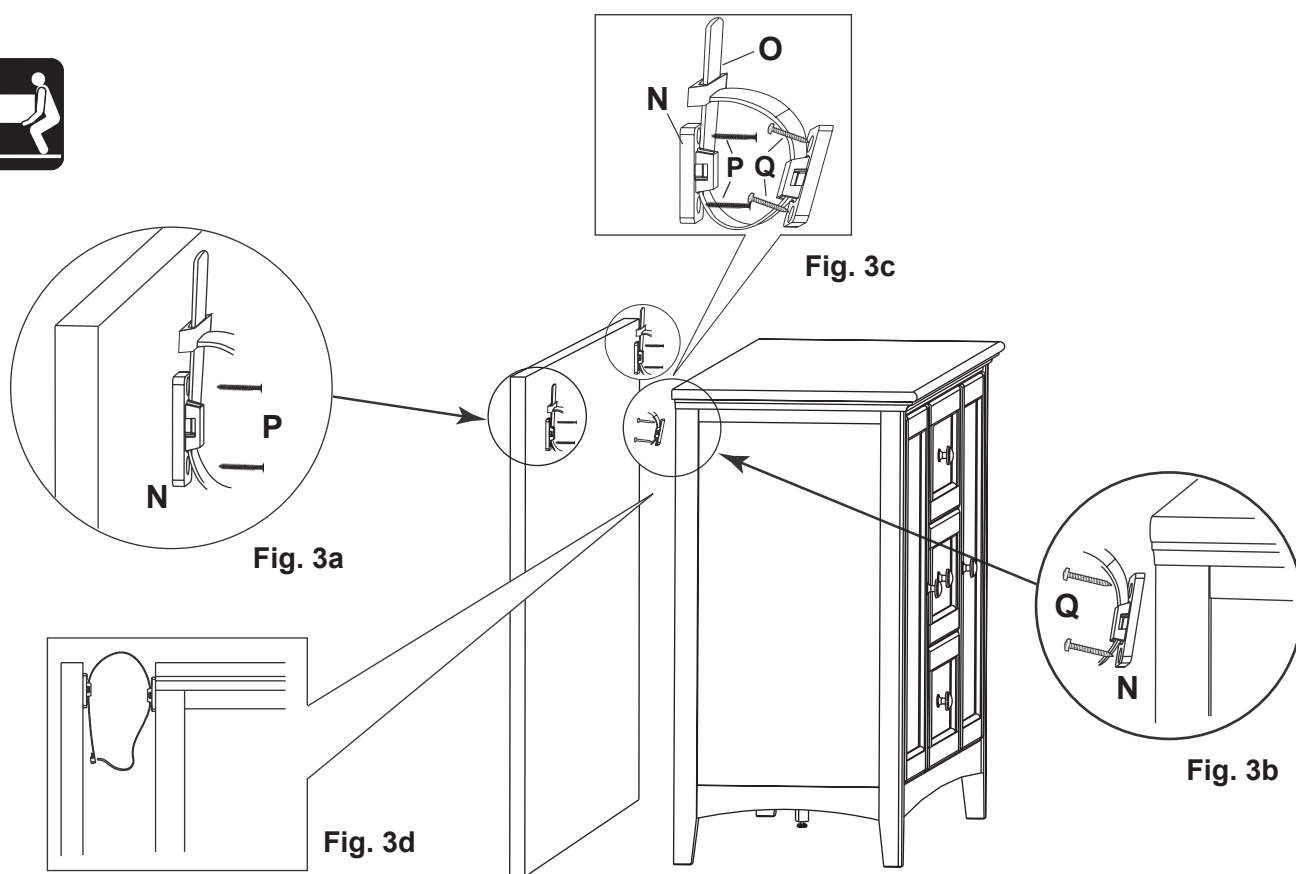

## Tipping Restraint

3. Position unit at desired location. Locate stud in the wall behind unit. Attach Clip (N) to wall stud with #8 x 2" Black Screws (P). See Figure 3a. Attach second clip to unit with #8 x 1" Pan Head Screws (Q). See Figure 3b. Connect the two clips with Nylon Restraint Strap (O). See Figures 3c and 3d. If studs cannot be located, purchase proper attachment hardware for your type of wall and secure unit according to that hardware's instructions.

# Finishing Hints

## Choosing the Finish:

1. Choose a finish that will meet your expectations for the product you are finishing. Are you matching existing furniture or do you want a "natural" finish? Is the piece to be functional, decorative or both? The answers to these questions may affect the type of finish you choose.
2. Use products of the same brand to ensure compatibility of products.
3. **ALWAYS** follow the stain manufacturer's instructions. Alder is a porous hardwood and often looks best when following the finishing directions for softwoods
4. We recommend using a wood conditioner under oil base stains.
5. Work in a well ventilated and well lit area.

## Getting Started

1. **Assembly Instructions may contain special finishing information for that item.** Read both the Assembly Instructions and these Finishing Hints completely before beginning.
2. Sand the entire piece, using #220 grit sandpaper. Sand with the grain of the wood on flat surfaces and opposite the grain on turnings. Some parts are plywood. Be careful not to sand through the veneer. End grain (table top ends, seat edges, grooves on turnings, etc.) accepts more stain. Extra sanding in these areas with a #320 grit sandpaper will reduce stain absorption, creating a more evenly stained piece.
3. When sanding is completed, wipe the surface of your furniture with a cloth or tack rag. Make sure the item is free of dust before proceeding.

## Staining

1. Read and follow label directions. Stir stain well before starting.
2. Test stain on an inconspicuous spot on your project, or use the sample chip if one is provided. The sample chip must be sanded in the same way as your furniture kit to ensure the piece will accept the stain similarly. Put at least one coat of your top coat over the stain sample, as it also affects the look of the stain. **Test every type of wood that is in your kit.** Some of our products include more than one type of wood, which may react differently to the stain color. Sample chips for the different woods may be included. It may be necessary to add a second coat of stain to lighter woods to match the darker woods in your kit.

## Basic Equipment:

- |  |   |  |
|--|---|--|
| <input type="checkbox"/> Rubber gloves | <input type="checkbox"/> Tack cloth                       | <input type="checkbox"/> #220 & #320 sandpaper |
| <input type="checkbox"/> Rags          | <input type="checkbox"/> Drop cloth                       | <input type="checkbox"/> Mineral spirits       |
| <input type="checkbox"/> Paper towels  | <input type="checkbox"/> Paint brushes (bristle and foam) | <input type="checkbox"/> Masking Tape          |
| <input type="checkbox"/> Q-tips        |   |  |

3. Apply stain with a poly brush or lint-free cloth. Apply stain over a small area and wipe off excess. Working in small areas will make the color easier to control.
4. Q-tips are ideal for hard to reach areas.
5. Allow to dry thoroughly before proceeding.

## Applying the Top Coat:

**No top coat is required if using paint.**

1. **Always read and follow all label directions.** Stir your finish coat gently, **do not shake.** It will create bubbles that are hard to remove.
2. **All surfaces** (including the underside of table tops and inside drawers) **must be sealed with at least one layer of a top coat.** This will help minimize wood swelling, shrinkage, warping and cupping due to changes in moisture content or temperature.
3. We recommend that you **apply a minimum of two coats when using polyurethane or varnish (especially on all table top and work surfaces).** Sand lightly between coats using a #320 grit sandpaper or 00 steel wool for the smoothest possible finish.
4. Some water-based finishes tend to raise the grain slightly. This can be easily controlled with this sanding step. However, do not use steel wool when using water-based finishes. Strands of steel fiber caught in the wood can cause rust spots when coated with any water-based product.

## Painting:

1. For best results when painting, first coat the wood with a primer. An oil based primer would be best for a smooth finish. If you do not wish to use a solvent based primer, a water based primer would work almost as well.
2. Buy a quality brand paint. You may use a satin, semi-gloss, or gloss sheen. Apply a second coat for a smooth finish. Lightly sand between coats using a #320 grit sandpaper, so that the second coat will bond well. Repeat as desired.
3. Since there is such a variation between paint manufacturers, refer to your paint supplier for specific advice on using the paint that you purchase.