

# McKenzie Occasional Table

**GAC = Glazed Antique Cherry finish**

**CAF = Caffè finish**

*Assembly Instructions*

Model #

**3497GACa;**

**3497CAFa**

**McKenzie Accent Table**

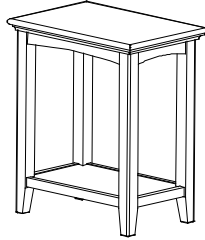

**3498GACa;**

**3498CAFa**

**McKenzie Side Table**

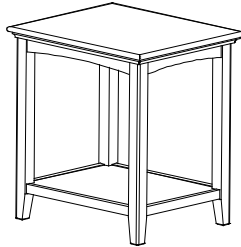

*Thank you for allowing us to help you furnish your home. We are certain you will be delighted with your new furniture for many years to come.*

## IMPORTANT NOTES:

- For normal household use only. *Not* recommended for commercial use.
- Do not climb, sit, or stand on this piece of furniture.
- Unload items before you move this unit.
- Do not overload the shelves.

## **WARNING**

Drilling, sawing, sanding or machining wood products can expose you to wood dust, a substance known to the state of California to cause cancer. Avoid inhaling wood dust or use a dust mask or other safeguards for personal protection.

For more information go to: [www.p65warnings.ca.gov/wood](http://www.p65warnings.ca.gov/wood)

This product can expose you to chemicals, including formaldehyde, which are known to the State of California to cause cancer.

For more information go to: [www.p65warnings.ca.gov/furniture](http://www.p65warnings.ca.gov/furniture)

**DESIGN SUBJECT TO CHANGE WITHOUT NOTICE.**

## CUSTOMER SERVICE

If you ever have questions about your furniture, please do not hesitate to contact us. In the unlikely event you need a replacement part; we can make those parts available through an authorized Whittier Wood Furniture dealer. If you cannot order replacement parts through your dealer, please contact our customer service department.

**Hours:** Our friendly customer service staff can be reached:

**Monday-Friday 8:00 a.m. to 5:00 p.m. (Pacific Time).**

You may leave a message 24 hours a day, seven days a week.

**Customer Service: 800-653-3336 • Outside the U.S.: 541-687-0213**

**Fax: 541-687-2060 • Email: [info@whittierwood.com](mailto:info@whittierwood.com)**

**Whittier  
Wood**  
FURNITURE

P.O. Box 2827  
Eugene, OR 97402 USA

Production Code:







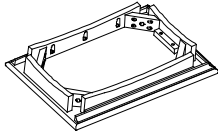
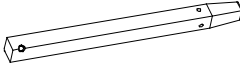
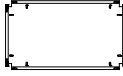
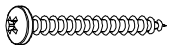

VN

02/17

**3497GACa; 3497CAFa McKenzie Accent Table;  
3498GACa; 3498CAFa McKenzie Side Table**

*Parts List*

Please identify the parts and check that quantities received match those on this list.  
If you need to replace a part, refer to the following letter and part name.

Part	Description		Quantity
Aa	Top Assembly		1
B	Leg		4
C	Shelf Assembly		1
D	#8 x 1-1/4" Pan Head Screw		30 (22 inserted)
E	5/16" Flat Washer		4
F	3/8" x 2-1/2" Hex Bolt		4
H	3/8" x 1" Insert Nut (inserted)		4
J	Adjustable Glide (installed)		4
K	Wood Dowel (inserted)		4
L	1/4" x 20mm Insert Nut (inserted)		4
M	#8 x 1-3/8" Lo-Profile Screw (inserted)		4
N	#8 Washer (inserted)		6

*3497 shown in the illustrations.*

**3497GACa; 3497CAFa McKenzie Accent Table;  
3498GACa; 3498CAFa McKenzie Side Table**  
*Assembly Instructions*

**Tools Required: Phillips Screwdriver, 9/16" or Adjustable Wrench**

1. Turn the Top Assembly (Aa) upside-down on a clean, protected surface. Position the Legs (B) in the corners so the Insert Nuts (H) face in. LOOSELY attach with four 5/16" Flat Washers (E) and four 3/8" x 2-1/2" Hex Bolts (F) (the legs should be wobbly). See Figures 1 and 1a.

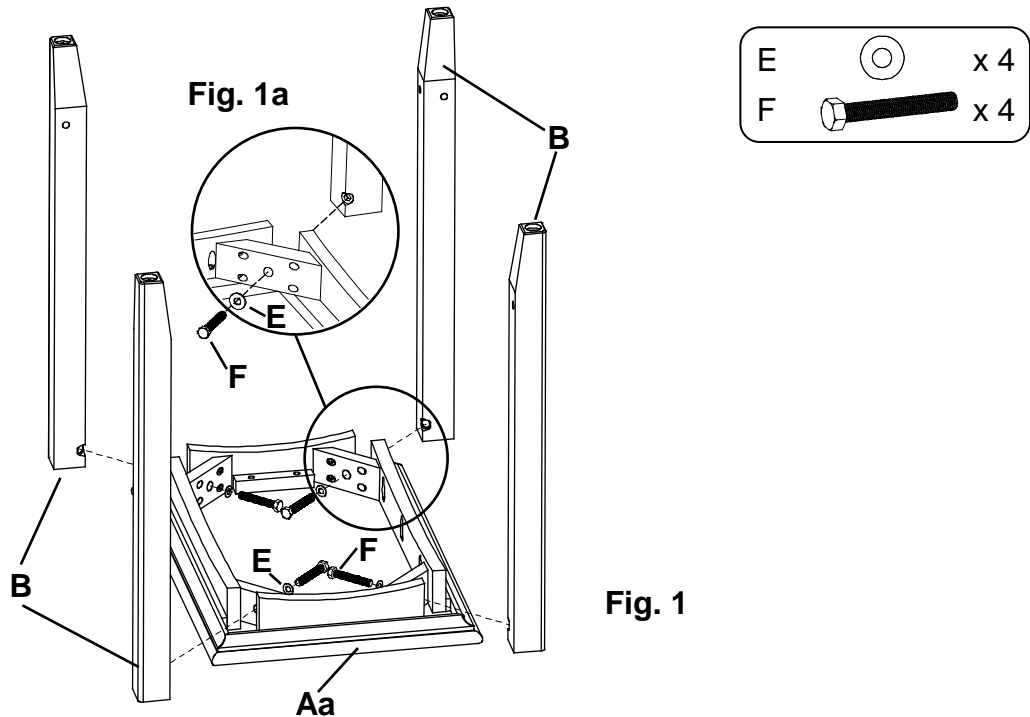

2. Turn the Shelf Assembly (C) upside-down and place the dowels into the dowel holes in the Legs. Tighten the Hex Bolts on the Legs. See Figure 2.

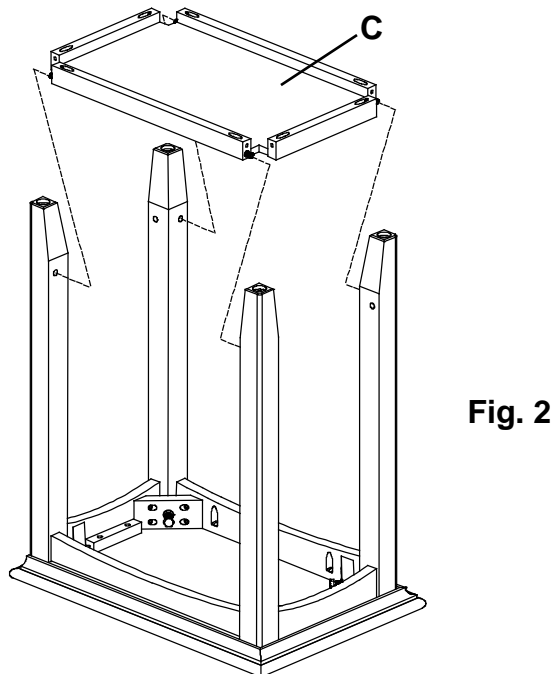

**3497GACa; 3497CAFa McKenzie Accent Table;  
3498GACa; 3498CAFa McKenzie Side Table**  
*Assembly Instructions*

---

3. Using the pocket holes as guides, secure the Shelf (C) to the Legs (B) with eight #8 x 1-1/4" Pan Head Screws (D). See Figures 3 and 3a.

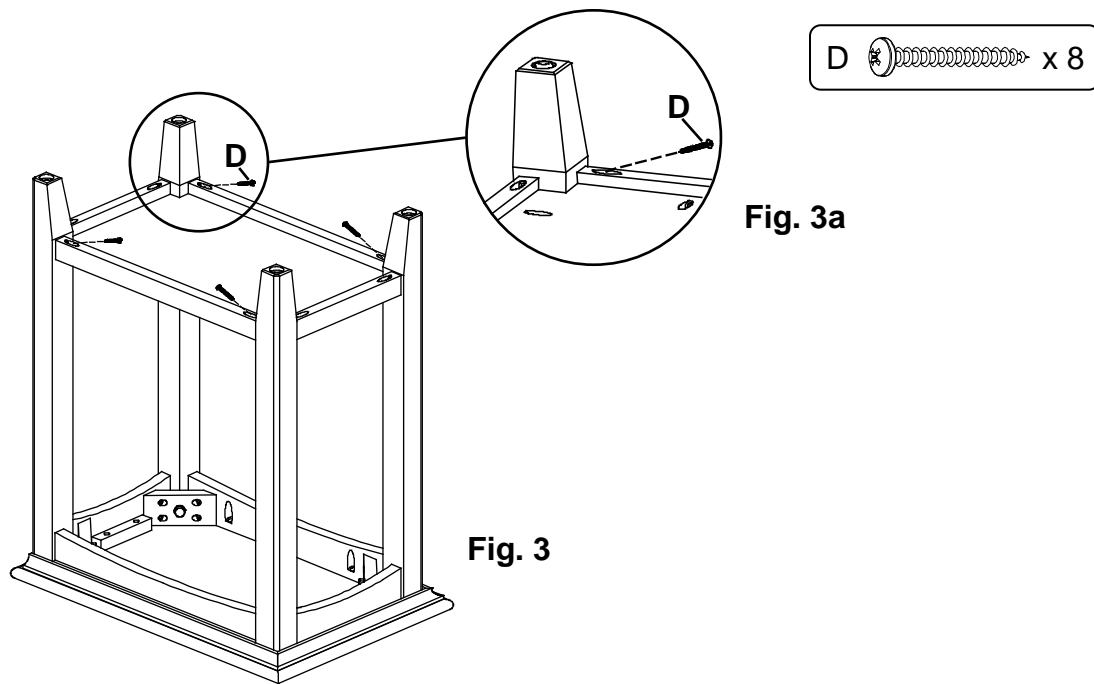

4. Turn the table upright and place the table at its final destination. To level the table, rotate the Adjustable Glides (J) found on the bottoms of the legs.

