

Addison Storage Consoles

DUET finish

Assembly Instructions

Model #

3525DUETa
Addison 37"W
Storage Console

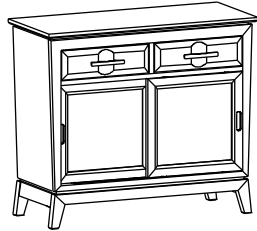

3526DUETa
Addison 54"W
Storage Console

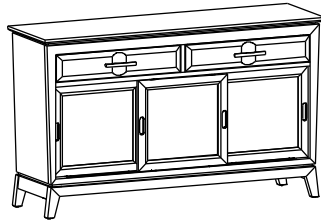

Thank you for allowing us to help you furnish your home. We are certain you will be delighted with your new furniture for many years to come.

IMPORTANT NOTES:

- Wood can be susceptible to changing color over time when exposed to strong sunlight. Use window shades, drapes or blinds to protect your furniture. To help the surface age evenly and avoid dark and light spots, periodically move items to expose the entire surface to an even amount of light so it may develop a uniform patina.
- For normal household use only. *Not* recommended for commercial use.
- Do not climb, sit or stand on this piece of furniture.
- Do not overload the drawers or shelves.
- Unload items before you move this unit.
- Before you begin your project, completely read the Assembly Instructions.
- This assembly requires two people.

! WARNING

Serious or fatal crushing injuries can occur from furniture tip-over. Use of tip-over restraints may only reduce but not eliminate the risk of tip-over.

To help prevent tip-over:

- Place heaviest items in the bottom drawers.
- Unless specifically designed to accommodate, do not set TVs or other heavy objects on top of this product.
- Never allow children to climb or hang on drawers, doors or shelves.
- Never open more than one drawer at a time.

Warning: At least one tipping restraint kit was included with your piece of Whittier Wood Furniture. When you receive your furniture, be sure to find and properly install the tipping restraint(s). If you cannot locate the restraint(s), please contact us immediately for replacement.

Drilling, sawing, sanding or machining wood products can expose you to wood dust, a substance known to the state of California to cause cancer. Avoid inhaling wood dust or use a dust mask or other safeguards for personal protection.

For more information go to: www.p65warnings.ca.gov/wood

This product can expose you to chemicals, including formaldehyde, which are known to the State of California to cause cancer.

For more information go to: www.p65warnings.ca.gov/furniture

DESIGN SUBJECT TO CHANGE WITHOUT NOTICE.

CUSTOMER SERVICE

If you ever have questions about your furniture, please do not hesitate to contact us. In the unlikely event you need a replacement part; we can make those parts available through an authorized Whittier Wood Furniture dealer. If you cannot order replacement parts through your dealer, please contact our customer service department.

Hours: Our friendly customer service staff can be reached:

Monday-Friday 8:00 a.m. to 5:00 p.m. (Pacific Time).

You may leave a message 24 hours a day, seven days a week.

Customer Service: 800-653-3336 • Outside the U.S.: 541-687-0213

Fax: 541-687-2060 • Email: info@whittierwood.com

**Whittier
Wood**
FURNITURE

P.O. Box 2827
Eugene, OR 97402 USA

Production Code:









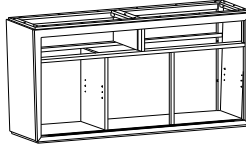
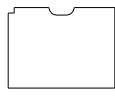
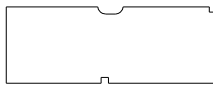
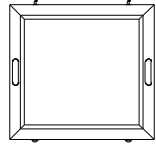
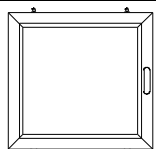

VN

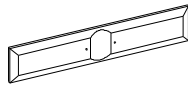
08/18

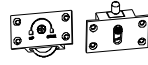
3525DUETa Addison 37"W Storage Console
3526DUETa Addison 54"W Storage Console





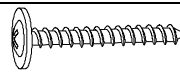
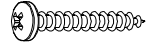
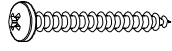



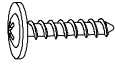
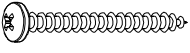

Parts List

Please identify the parts and check that quantities received match those on this list.
 If you need to replace a part, refer to the following letter and part name.

Part	Description	Quantity	
		3525DUETa	3526DUETa
A	Top Assembly (attached) 	1	1
Ba	Case 	1	1
C	Short Adjustable Shelf (installed) 	0	1
D	Long Adjustable Shelf (installed) 	1	1
E	Inside Door (installed) 	1	3
F	Outside Door (installed) 	1	0
G	Drawer Box (inserted) 	2	2
H	Drawer Face (installed) 	2	2
I	Base (attached) 	1	1
J	14" Drawer Slides (pre-installed sets) 	2	2
K	Door Roller (pre-installed sets) 	4	6
L	#6 x 5/8" Undercut Screw AB (inserted) 	32	48
M	#6 x 3/4" Philtruss Screw (inserted) 	12	12
N	#6 x 1/2" Undercut Screw AB (inserted) 	4	8
O	#6 x 3/4" Flat Head Screw (inserted) 	20	20
P	#6 x 1/2" Philtruss Screw (inserted) 	12	12
Q	#8 x 1-3/8" Lo-Profile Screw (inserted) 	17	17
R	#8 x 1" Pan Head Screw (inserted) 	6	6
S	#8 x 1-1/4" Pan Head Screw (inserted) 	14	14

3525DUETa Addison 37"W Storage Console
3526DUETa Addison 54"W Storage Console

Parts List

Part	Description	Quantity	
		3525DUETa	3526DUETa
T	#8 x 7/8" Black Lo-Profile Screw (inserted) 	32	36
U	#8 x 1-3/4" Pan Head Screw (inserted) 	12	18
V	#8 x 1-5/8" Black Screw (inserted) 	9	11
W	#8 x 1-5/8" Machine Screw Tuscan (installed) 	4	4
X	1/4" x 20mm Insert Nut (inserted) 	4	4
Y	5/32" x 10mm Insert Nut (inserted) 	4	4
ZA	Black Walnut Pull (attached) 	2	2
ZB	Front 4-Hole Bracket (attached) 	2	2
ZC	Back 6-Hole Bracket (attached) 	2	2
ZD	Small Adjustable Glide (installed) 	4	4
ZE	Shelf Bracket (installed) 	4	8
TS	Furniture Tipping Restraint (attached)	1 set	1 set

3526 shown in the illustrations.

3525DUETa Addison 37"W Storage Console
3526DUETa Addison 54"W Storage Console
Assembly Instructions

Tools Required: Phillips Screwdriver, Pencil.

1. Remove screws from the plywood supports and side aprons. Recycle or discard. See Figure 1.

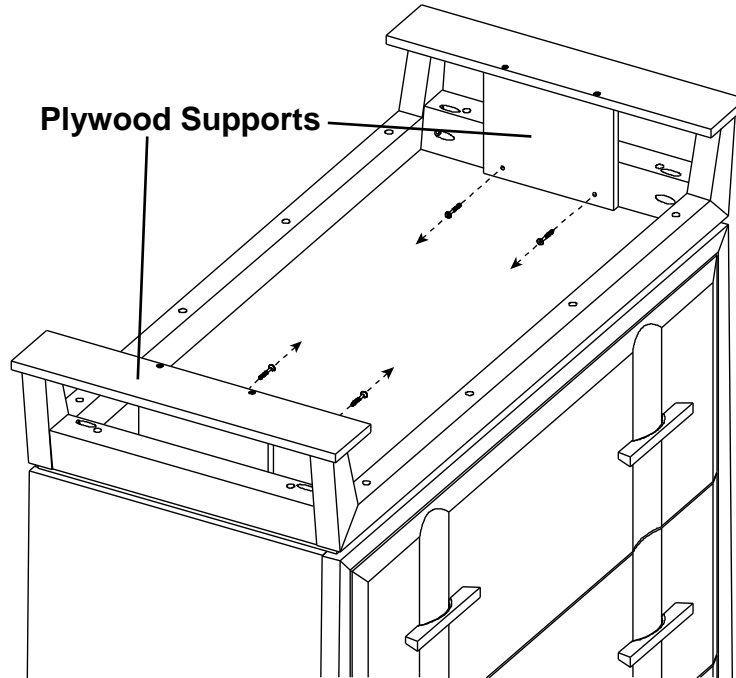

Fig. 1

2. Place the chest at its final destination. Rotate the Small Adjustable Glides (ZD) on the bottoms of the legs until the unit is level. See Figure 2.

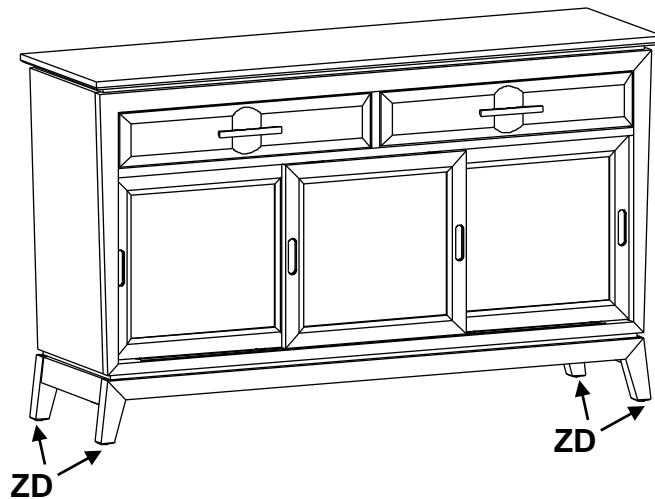
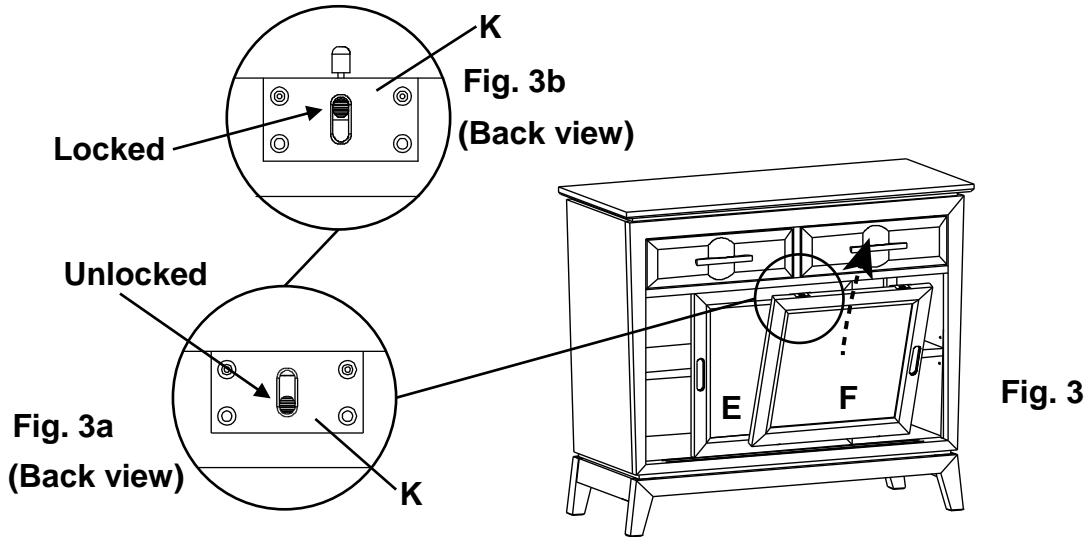

Fig. 2

3525DUETa Addison 37"W Storage Console
3526DUETa Addison 54"W Storage Console
Assembly Instructions

3. For model #3525DUET:

To remove the doors (E & F) shift both doors to the center of the case. Shift the Outside Door (F) to one side, reach behind the top rail of the door and locate the pin portion of the Door Roller (K). See Figure 3. Slide the lock lever downward as shown in Figure 3a. Then shift the door to the other side and slide the lever down on that piece. You may then tip the upper edge of the door forward and remove the door. Remove the Inside Door (E) in the same manner. To insert the doors reverse this process. Be sure to slide the lock lever up to lock the Door Rollers (K). See Figures 3, 3a, 3b.



4. For model #3526DUET:

To remove the doors (E) shift one of the back doors to the far right of the case. Move the remaining two doors to the center of the case. See Figure 4. Shift the front door to one side, reach behind the top rail of the door and locate the pin portion of the Door Roller (K). See Figure 4. Slide the lock lever downward as shown in Figure 4a. Then shift the door to the other side and slide the lever down on that piece. You may then tip the upper edge of the door forward and remove the door. Remove the back doors in the same manner. To insert the doors reverse this process. Be sure to slide the lock lever up to lock the Door Rollers (K). See Figures 4, 4a, 4b.

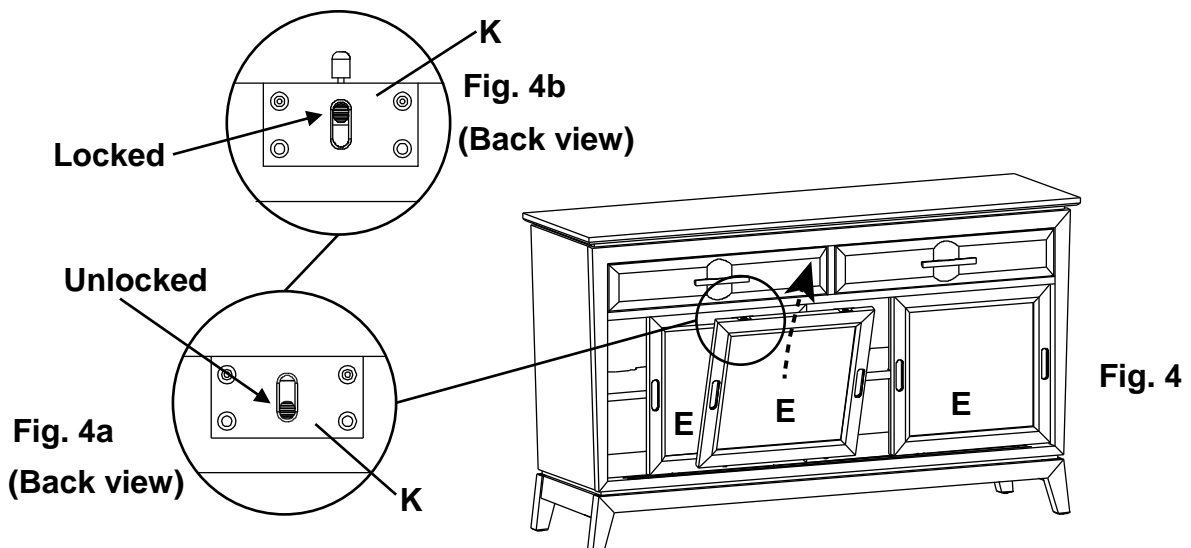

3525DUETa Addison 37"W Storage Console
3526DUETa Addison 54"W Storage Console
Assembly Instructions

5. To move the Adjustable Shelves (C and D), remove the #6 x 1/2" Undercut Screws (N) and the Shelves (C and D). Reposition the Shelf Brackets (ZE) to the desired positions, replace the shelves and insert the screws. See Figures 5 and 5a.

Doors removed for illustration purposes.

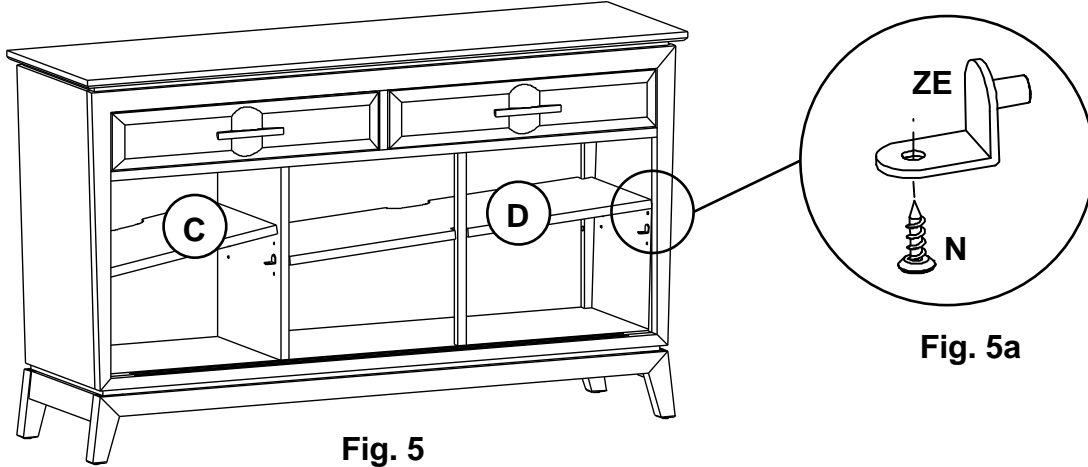

Continued on Page 7

3525DUETa Addison 37"W Storage Console
3526DUETa Addison 54"W Storage Console
Assembly Instructions

Furniture Tipping Restraint Instructions

Before you begin this assembly, identify each part and make sure the quantities received match what is on this list. If you need to replace a part, contact Whittier Wood Furniture customer service and refer to the following list for its name and letter code.

Part	Description	Quantity
A	Cam Buckle and Short Strap (installed)	1
B	Plastic Bracket (installed)	1
C	1" x 1000mm Long Strap (installed)	1
D	#8 x 3" Pan Head Screw	2
E	#10 x 1" Oval Head Screw (inserted)	1
F	Washer	1

If you have a stone or tile floor or do not wish to drive screws into the corner of the baseboard and floor see the instruction included inside the tipping restraint kit for an alternate installation.

- Decide where you want to place the piece of furniture in your room. Mark the baseboard with a pencil mark directly behind the location where the tipping restraint is attached to your item. Move the item away from the wall far enough to allow you to access the spot where the baseboard meets the floor. Position the straps and Plastic Bracket (B) as shown in Figures 6 and 6a with the angled corners of the Plastic Bracket (B) firmly placed against the seam of the baseboard and floor. Attach by driving #8 x 3" Pan Head Screws (D) through the holes in the Plastic Bracket (B) into the seam below the baseboard where it meets the floor. See Figures 6 and 6a.

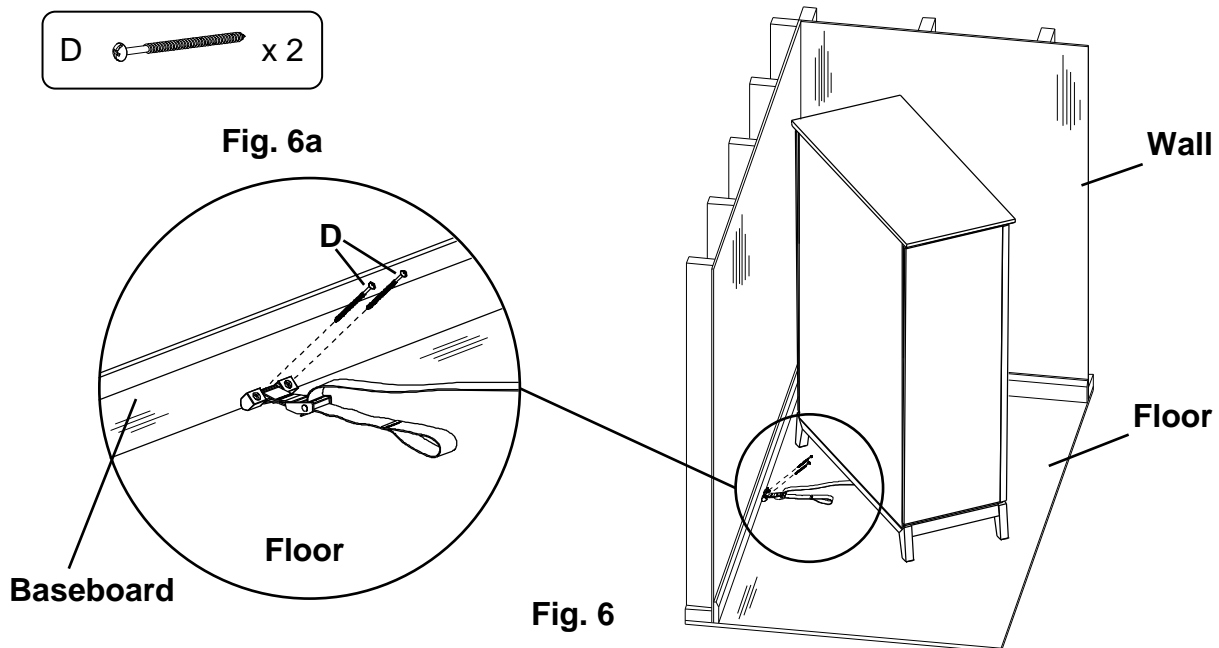

3525DUETa Addison 37"W Storage Console
3526DUETa Addison 54"W Storage Console
Assembly Instructions

7. Move the item back into position against the wall and reach underneath the piece of furniture to grasp the loop in the free end of the strap. Pull the free end of the strap until portion between the Cam Buckle (A) and the back apron of the item is tight. See Figures 7 and 7a. If you need to move the piece of furniture reach beneath and locate the buckle which connects the two sections of the strap and depress the release lever, then pull on the section of strap that is between the buckle and the back apron of the furniture until there is enough slack to allow you to pull the item away from the wall.

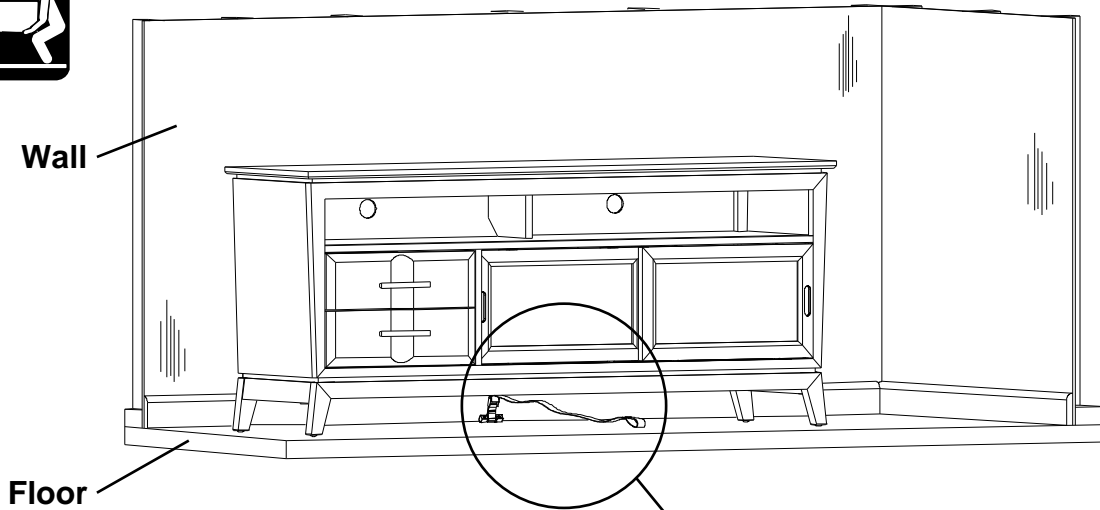

Fig. 7

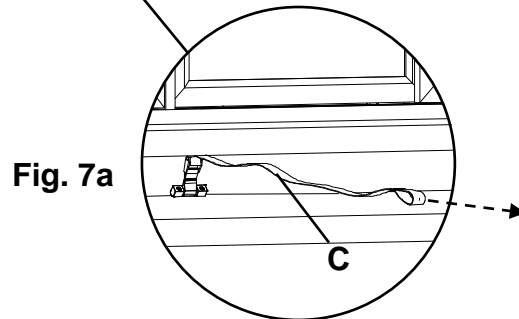

Fig. 7a