

Addi Tables

Duet = Natural finish

Assembly Instructions

Model #

3531 DUET Addi Round Side Table



3534 DUET Addi Cocktail End Table

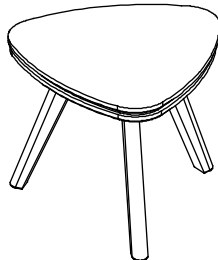

Thank you for allowing us to help you furnish your home. We are certain you will be delighted with your new furniture for many years to come.

IMPORTANT NOTES:

- For normal household use only. *Not* recommended for commercial use.
- Do not climb, sit, or stand on this piece of furniture.
- Unload items before you move this unit.

WARNING

Drilling, sawing, sanding or machining wood products can expose you to wood dust, a substance known to the state of California to cause cancer. Avoid inhaling wood dust or use a dust mask or other safeguards for personal protection.

For more information go to: www.p65warnings.ca.gov/wood

This product can expose you to chemicals, including formaldehyde, which are known to the State of California to cause cancer. For more information go to: www.p65warnings.ca.gov/furniture

DESIGN SUBJECT TO CHANGE WITHOUT NOTICE.

CUSTOMER SERVICE

If you ever have questions about your furniture, please do not hesitate to contact us. In the unlikely event you need a replacement part; we can make those parts available through an authorized Whittier Wood Furniture dealer. If you cannot order replacement parts through your dealer, please contact our customer service department.

Hours: Our friendly customer service staff can be reached:

Monday-Friday 8:00 a.m. to 5:00 p.m. (Pacific Time).

You may leave a message 24 hours a day, seven days a week.

Customer Service: 800-653-3336 • **Outside the U.S.:** 541-687-0213

Fax: 541-687-2060 • **Email:** info@whittierwood.com

**Whittier
Wood**
FURNITURE

P.O. Box 2827
Eugene, OR 97402 USA







Production Code:

VN

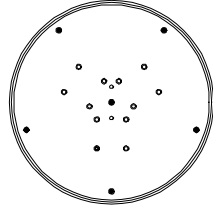
02/18

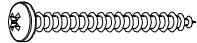
3531DUET Addi Round Side Table
3534DUET Addi Cocktail End Table
Parts List

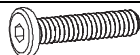
Please identify the parts and check that quantities received match those on this list.
 If you need to replace a part, refer to the following letter and part name.

Part	Description	Quantity
A	Top Assembly 	1
B	Leg Assembly 	3
C	#8 x 1-3/4" Pan Head Screw (inserted) 	13
D	#8 Washer (inserted) 	7
E	5/16" x 14mm Insert Nut (inserted) 	12
F	5/16" x 30mm Hex Bolt 	12
G	Tack Glide (attached) 	3
H	Z Hex Wrench 5mm 	1

3531 shown in the illustrations.

**3531DUET Addi Round Side Table
3534DUET Addi Cocktail End Table**
Assembly Instructions

Tool Required: Z Hex Wrench 5mm (provided)

1. Turn the Top Assembly (A) upside-down on a clean, protected surface. Attach the first and second Legs (B) to the Top Assembly with eight 5/16" x 30mm Hex Bolts (F). See Figure 1.

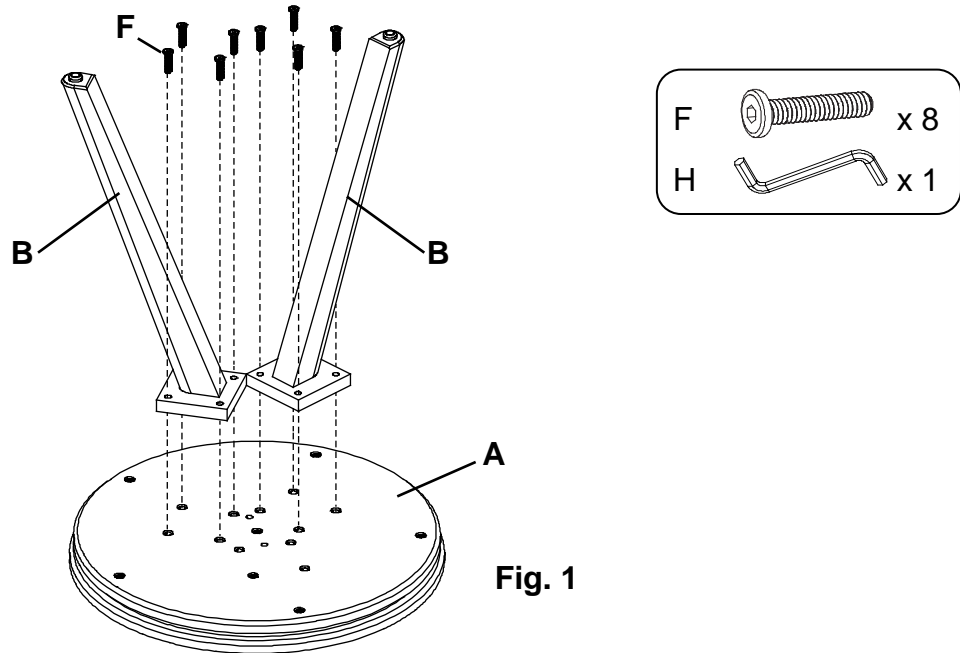

2. Attach the final Leg (B) to the Top Assembly with four 5/16" x 30mm Hex Bolts (F). See Figure 2.

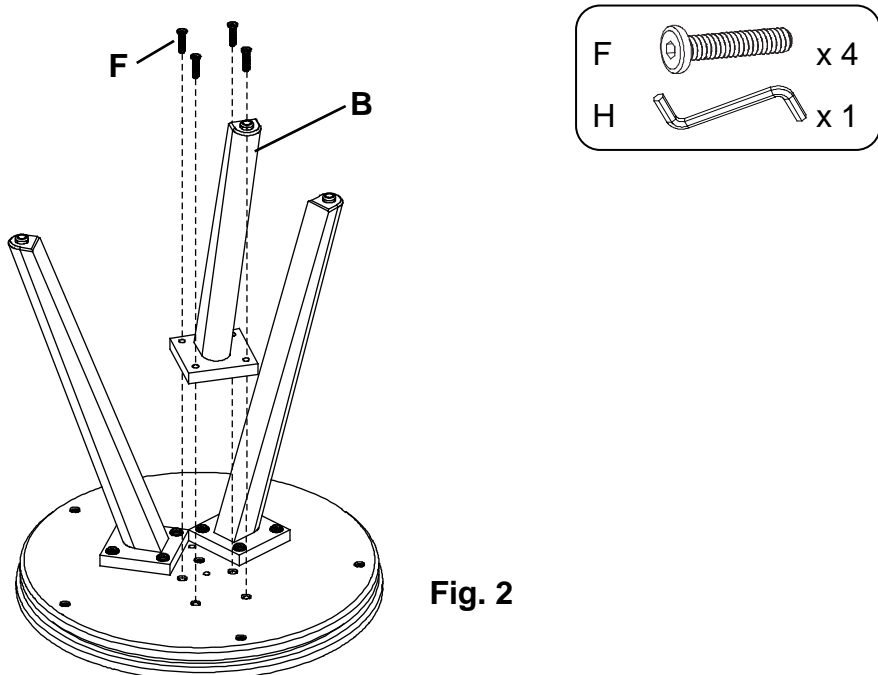

3531DUET Addi Round Side Table
3534DUET Addi Cocktail End Table
Assembly Instructions

3. Turn the table upright and place the table at its final destination.

