

Addison Black Walnut Adjustable Headboard Platform Beds

DUET finish

Assembly Instructions

Model #

3810DUET

Addison Queen Black Walnut
Adjustable Headboard Platform Bed

3812DUET

Addison King Black Walnut
Adjustable Headboard Platform Bed

3814DUET

Addison Cal-King Black Walnut
Adjustable Headboard Platform Bed

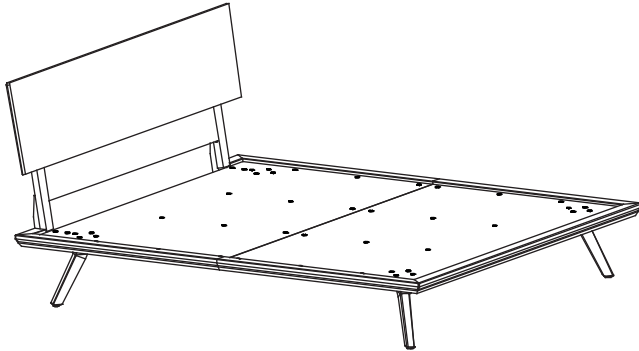

Thank you for allowing us to help you furnish your home. We are certain you will be delighted with your new furniture for many years to come.

IMPORTANT NOTES:

- For normal household use only. *Not* recommended for commercial use.
- Remove items before you move this unit.
- This assembly requires two people.



- This item has a total maximum combined weight limit of 850 lbs. inclusive of foundation and people.

! WARNING

Drilling, sawing, sanding or machining wood products can expose you to wood dust, a substance known to the state of California to cause cancer. Avoid inhaling wood dust or use a dust mask or other safeguards for personal protection.

For more information go to: www.p65warnings.ca.gov/wood

This product can expose you to chemicals, including formaldehyde, which are known to the State of California to cause cancer.

For more information go to: www.p65warnings.ca.gov/furniture

DESIGN SUBJECT TO CHANGE WITHOUT NOTICE.

CUSTOMER SERVICE

If you ever have questions about your furniture, please do not hesitate to contact us. In the unlikely event you need a replacement part; we can make those parts available through an authorized Whittier Wood Furniture dealer. If you cannot order replacement parts through your dealer, please contact our customer service department.

Hours: Our friendly customer service staff can be reached:

Monday-Friday 8:00 a.m. to 5:00 p.m. (Pacific Time).

You may leave a message 24 hours a day, seven days a week.

Customer Service: 800-653-3336 • **Outside the U.S.:** 541-687-0213

Fax: 541-687-2060 • **Email:** info@whittierwood.com

**Whittier
Wood**
FURNITURE

P.O. Box 2827
Eugene, OR 97402 USA

Production Code:

VN

08/17

3810DUET Addison Queen Black Walnut Adjustable Headboard Platform Bed
3812DUET Addison King Black Walnut Adjustable Headboard Platform Bed
3814DUET Addison Cal-King Black Walnut Adjustable Headboard Platform Bed
Parts List









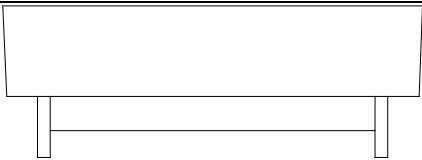

Please note this Assembly Instruction is for all three beds. Please identify the bed part number when ordering parts.

Please identify the parts and check that the quantities received match those on this list. If you need to replace a part, refer to the model number, part letter and name.

3811DUET Addison Queen Black Walnut Adjustable Platform Headboard Kit (x1)

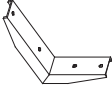

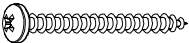



3813DUET Addison King Black Walnut Adjustable Platform Headboard Kit (x1)

3815DUET Addison Cal-King Black Walnut Adjustable Platform Headboard Kit (x1)

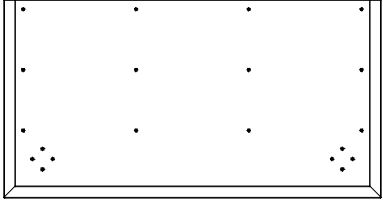
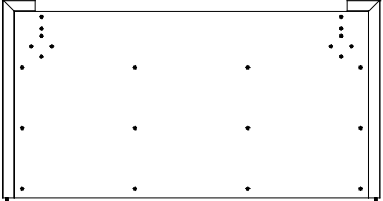
Part	Description		Quantity
A	Headboard Assembly		1
B	18mm Flat Washer		8
C	1/4" x 20mm Insert Nut (inserted)		4
D	1/4" x 22mm Hex Bolt		4
E	1/4" x 35mm Hex Bolt		4
F	5/16" x 14mm Insert Nut (inserted)		4
G	5/16" x 35mm Hex Bolt (inserted)		4
H	Headboard L Bracket		2
I	Z Hex Wrench 5mm (attached to the right leg)		1
M	#8 x 1-3/4" Pan Head Screw (inserted)		6
V	#8 Washer (inserted)		6

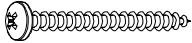
3810DUET Addison Queen Black Walnut Adjustable Headboard Platform Bed
 3812DUET Addison King Black Walnut Adjustable Headboard Platform Bed
 3814DUET Addison Cal-King Black Walnut Adjustable Headboard Platform Bed
Parts List



3802DUET Addison Queen Platform Kit (x1)
3806DUET Addison King Platform Kit (x1)
3809DUET Addison Cal-King Platform Kit (x1)

Part	Description	Quantity
J	End Platform Assembly 	1
K	Headboard Platform Assembly 	1
L	#8 x 1-1/8" Lo-Profile Screw (inserted) 	12
M	#8 x 1-3/4" Pan Head Screw (inserted) 	12
N	#8 x 1-5/8" Black Screw (inserted) 	33
O	1/4" T-Nut (inserted) 	44
P	Wood Dowel (inserted) 	2

3810DUET Addison Queen Black Walnut Adjustable Headboard Platform Bed
 3812DUET Addison King Black Walnut Adjustable Headboard Platform Bed
 3814DUET Addison Cal-King Black Walnut Adjustable Headboard Platform Bed
Parts List

3803DUET

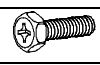
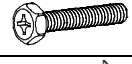
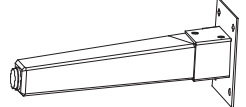
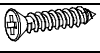
Addison Queen/King/Cal-King Platform Connector Kit (x1)

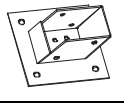
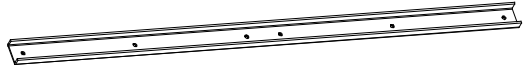
Part	Description		Quantity
B	18mm Flat Washer		40
D	1/4" x 22mm Hex Bolt		24
E	1/4" x 35mm Hex Bolt		16
Q	Foot Assembly		4
R	#6 x 3/4" Brass Flat Head Screw (Inserted)		24
S	Wool Felt Pad/Glide (Attached)		4
T	Metal Foot Bracket (Attached)		4
U	1500mm Channel		4

3810DUET Addison Queen Black Walnut Adjustable Headboard Platform Bed
3812DUET Addison King Black Walnut Adjustable Headboard Platform Bed
3814DUET Addison Cal-King Black Walnut Adjustable Headboard Platform Bed
Assembly Instructions

This assembly requires two people.

Tools Required: Phillips screwdriver, 7/16" open end or box end wrench.

Tool Provided: Z shaped Hex Wrench attached to the back right leg of the Headboard. See Figure 7b.

NOTE: Remove this instruction from the Headboard Kit carton. Place Headboard and attached hardware kit to the side (possibly in another room) to allow space for assembling the platform portion of the bed. Open the #3803 Platform Connector Kit, which attaches the two Platforms together.

1. Open and unfold the Platform Kit carton in the approximate location where the bed will be placed. This will help protect the flooring and the faces of the platform components. Place the Headboard Platform Assembly (K) face down in the approximate location where the headboard will be located with the inside edge facing the End Platform Assembly (J). Align the Dowels (P) in the edge of the Headboard Platform Assembly (K) with the holes in the edge of the End Platform Assembly (J) see Figures 1 and 1a.

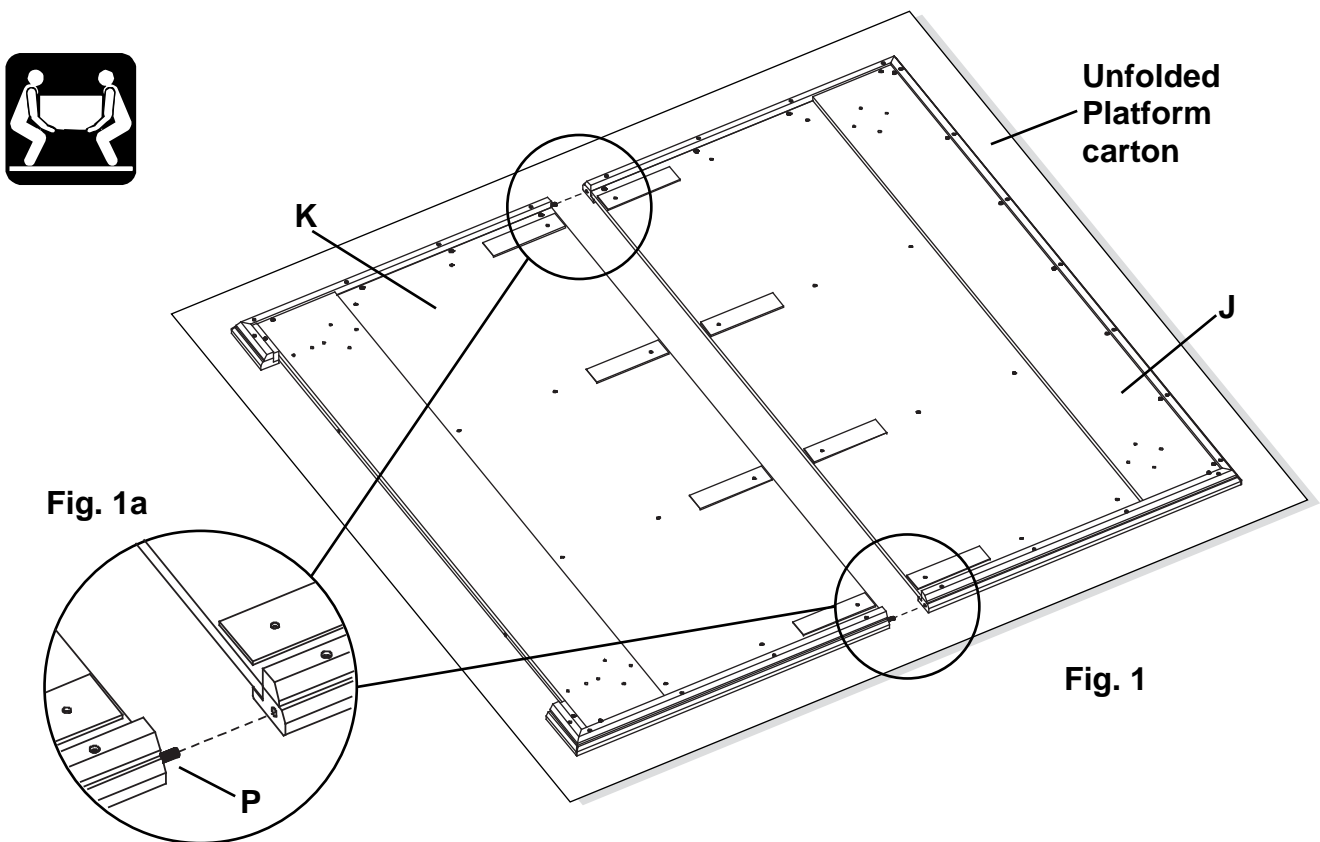



3810DUET Addison Queen Black Walnut Adjustable Headboard Platform Bed
3812DUET Addison King Black Walnut Adjustable Headboard Platform Bed
3814DUET Addison Cal-King Black Walnut Adjustable Headboard Platform Bed
Assembly Instructions

This assembly requires two people.

2. Slide the two sections together so that the flat edges touch as shown in Figure 2. Using the hardware from the #3803 Connector Kit, place the 1500mm Channels (U) on the Platform and align over the predrilled holes in the platform. Attach the Channels (U) with 1/4" X 22mm Hex Bolts (D) and 18mm Flat Washers (B). See Figures 2 and 2a.



Hardware bag step 2

B		x 24
D		x 24

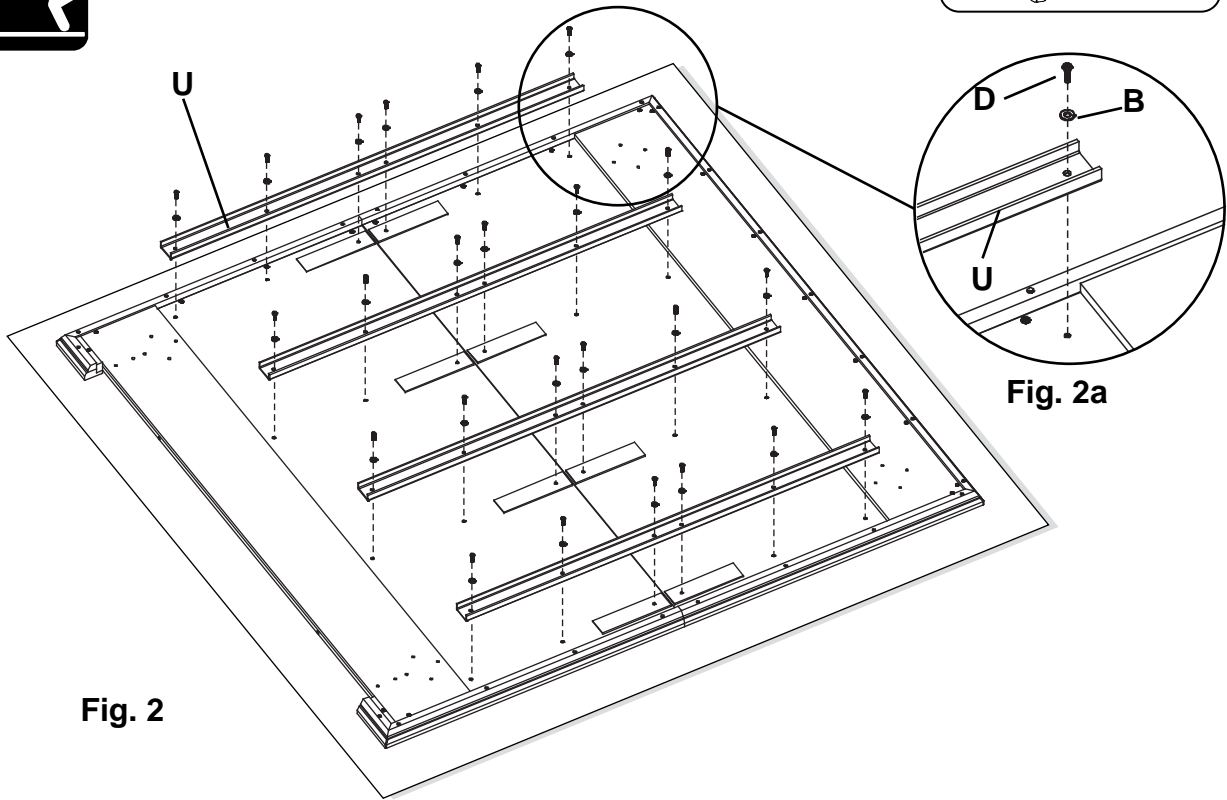

3810DUET Addison Queen Black Walnut Adjustable Headboard Platform Bed
3812DUET Addison King Black Walnut Adjustable Headboard Platform Bed
3814DUET Addison Cal-King Black Walnut Adjustable Headboard Platform Bed
Assembly Instructions

This assembly requires two people.

3. Place the Foot Assemblies (Q) onto the Platform Assembly so that the holes in the metal brackets align over the predrilled holes. The legs should angle outward toward the corner of the platform. Attach the Foot Assemblies (Q) with 1/4" X 35mm Hex Bolts (E) and 18mm Flat washers (B). See Figures 3 and 3a.

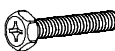

Hardware bag step 3

B		x 16
E		x 16

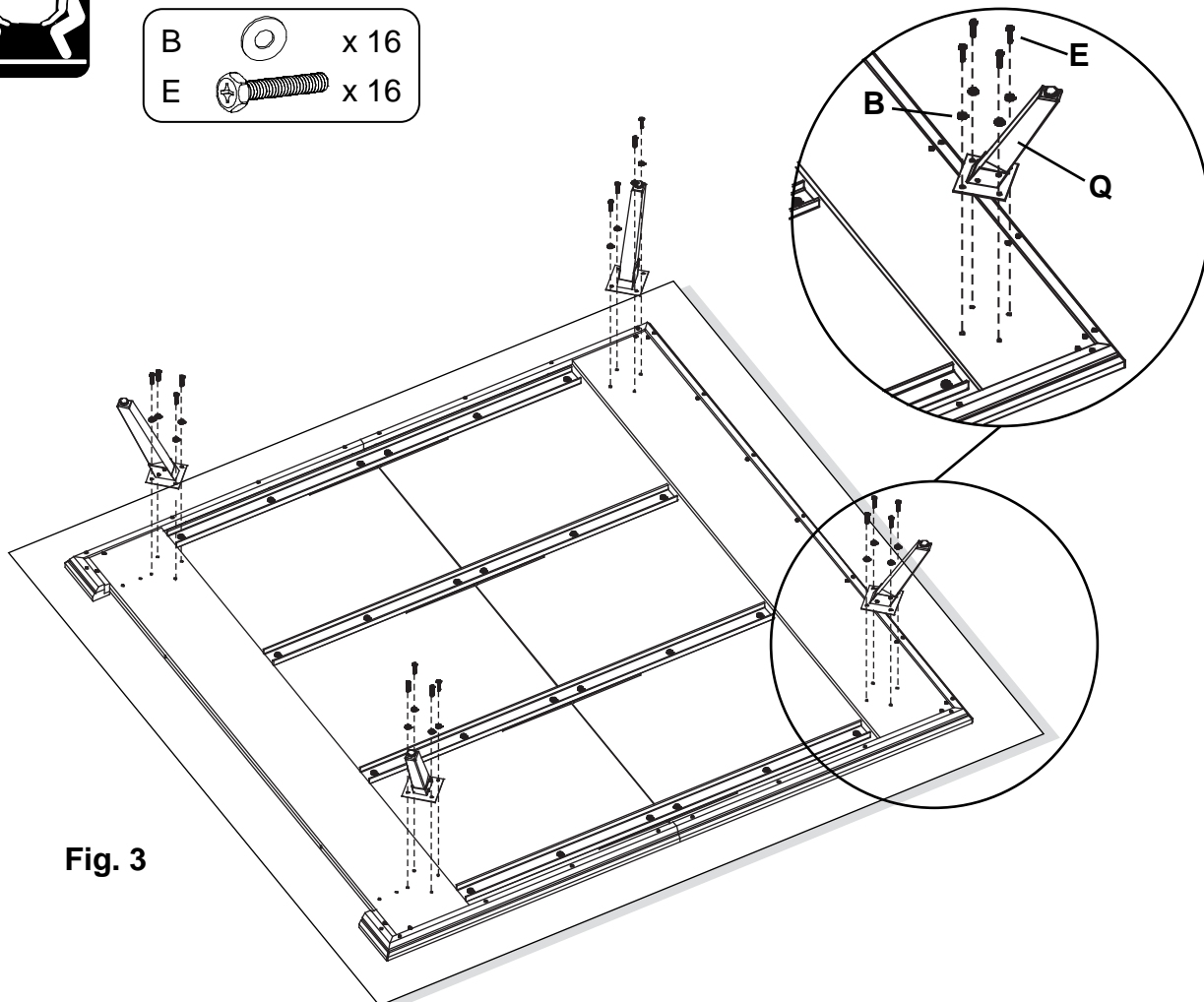



Fig. 3

Fig. 3a

3810DUET Addison Queen Black Walnut Adjustable Headboard Platform Bed
3812DUET Addison King Black Walnut Adjustable Headboard Platform Bed
3814DUET Addison Cal-King Black Walnut Adjustable Headboard Platform Bed



Assembly Instructions

This assembly requires two people.

4.  **CAUTION NEEDED:** Flip the Platform Assembly over onto the feet. Use extreme care not to bump into light fixtures, ceiling fans, walls, ceiling, or other objects in the room. Protect the corners of the Platform. Do not apply force to the Foot Assemblies (Q). Carefully slide the Platform carton out from beneath the Platform Assembly and recycle or discard.
5. Retrieve the Headboard and hardware kit. Position the Headboard Brackets (H) on the Platform Assembly as shown with the longer leg of the bracket extending upward and align to the pre-drilled holes in the bottom of the platform. Attach from the underside using 1/4" X 35mm Hex Bolts (E) and 18mm Flat Washers (B) as shown. Finger tighten the bolts at this time. See Figures 5 and 5a.



Hardware bag step 5

B		x 4
E		x 4

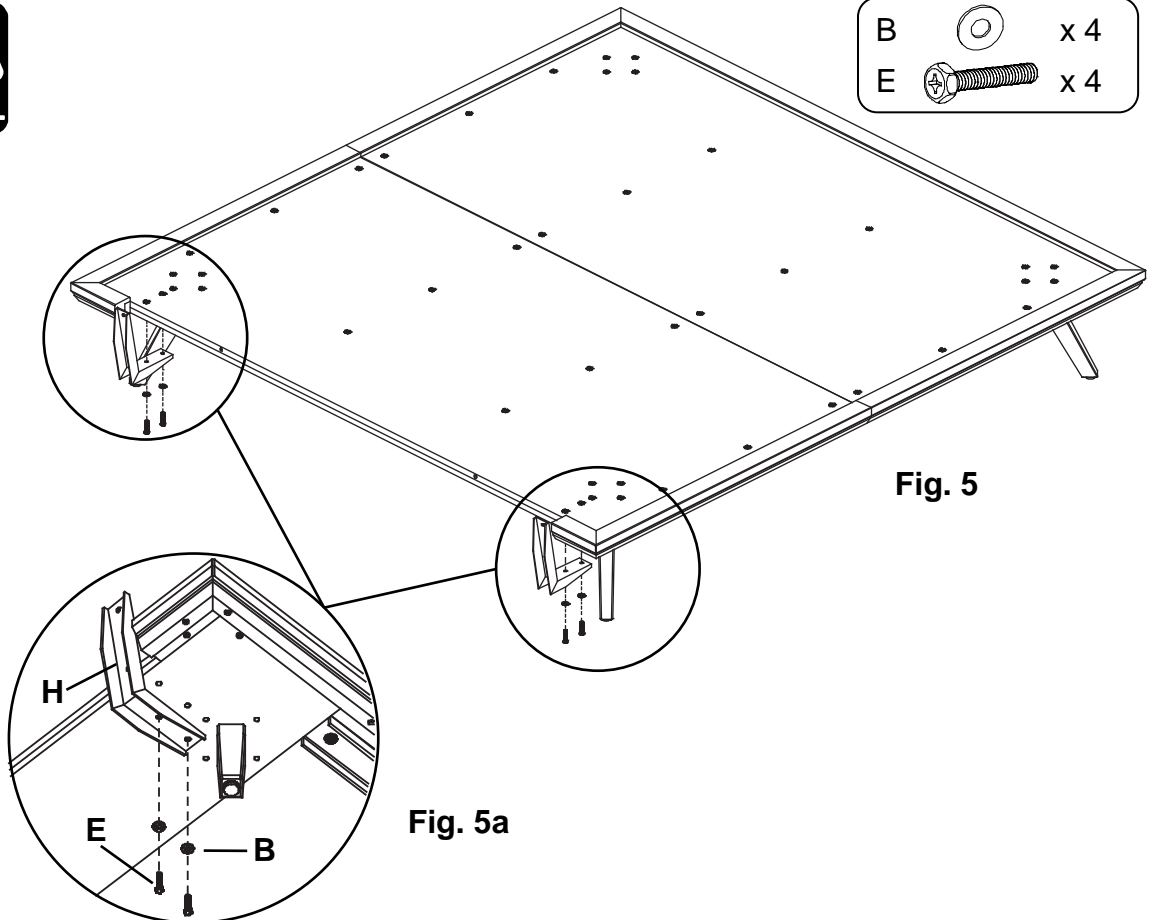

3810DUET Addison Queen Black Walnut Adjustable Headboard Platform Bed
3812DUET Addison King Black Walnut Adjustable Headboard Platform Bed
3814DUET Addison Cal-King Black Walnut Adjustable Headboard Platform Bed



Assembly Instructions

This assembly requires two people.

6. Attach the Headboard assembly (A) to the Platform Assembly as shown and secure with 1/4" X 22mm Hex Bolts (D) and 18mm Flat Washers (B). After tightening these bolts go back and tighten the bolts securing the brackets to the bottom of the Platform Assembly. See Figures 6 and 6a.



Hardware bag step 6

B		x 4
D		x 4

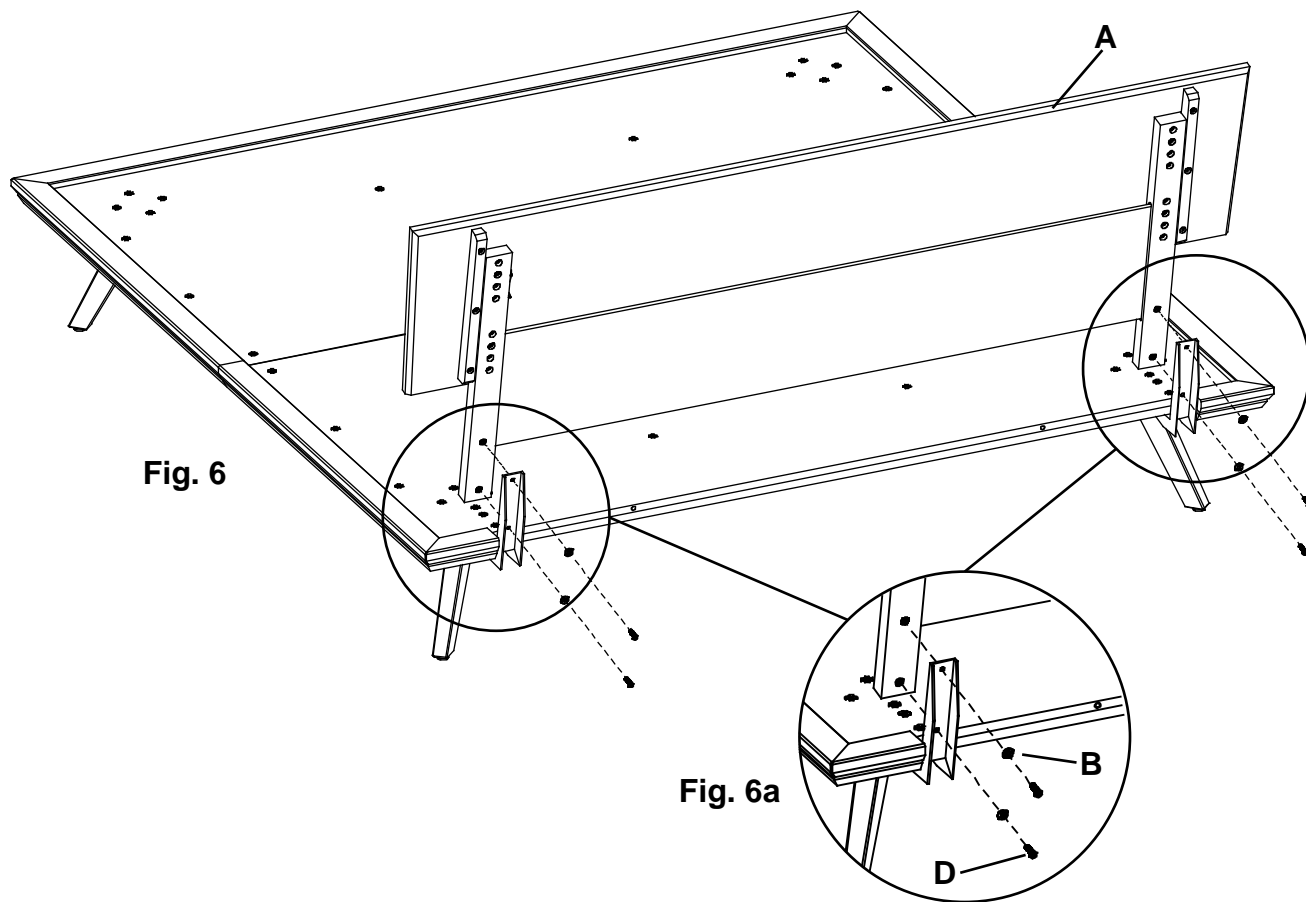

3810DUET Addison Queen Black Walnut Adjustable Headboard Platform Bed
3812DUET Addison King Black Walnut Adjustable Headboard Platform Bed
3814DUET Addison Cal-King Black Walnut Adjustable Headboard Platform Bed

Assembly Instructions

This assembly requires two people.

7. **NOTE:** When completing step 7 you may wish to place your mattress onto the Bed to use as a visual reference while adjusting the Headboard Height.

The Headboard for this bed is adjustable. It can be raised or lowered depending on the thickness of your mattress. The holes for adjusting the height are numbered on the back of the headboard legs. The chart below provides suggested settings based on the thickness of your mattress. It also lists the overall height of the headboard at each setting. You may choose a different setting for a variety of reasons. Individual preference, the number and thickness of pillows on your bed, or the presence of a window or artwork above the Headboard are some of the factors that might lead you to select a different setting than the one we have suggested. To adjust the setting of the headboard use the Hex wrench (I) provided to remove the 5/16" X 35mm Bolts (G) attaching the Headboard to the Legs of the Headboard. Reposition the Headboard so that the insert nuts in the back line up to the numbered holes that correspond to the height you desire. Reinsert the bolts. See Figures 7 and 7a.

Screw Position	Headboard Height	Approximate Mattress Thickness Range
1	43 1/8"	>12"
2	41 7/8"	11" to 12"
3	40 3/4"	10" to 11"
4	39 3/8"	8" to 10"



Hardware bag step 7

