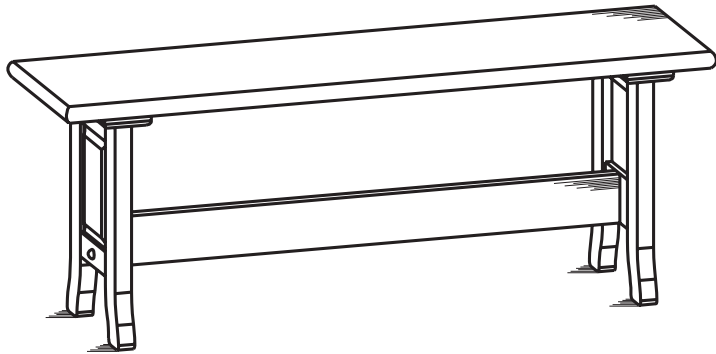


Model #

5023W

Portland Trestle Bench

Assembly Instructions



Congratulations!

*This fine piece of furniture will make a handsome addition to your home. For the best results, start by reading both the Assembly Instructions and Finishing Hints **before** you begin your project.*

**For normal household use only.
NOT recommended for commercial use.**



Do not climb or stand on this piece of furniture.

DESIGN SUBJECT TO CHANGE WITHOUT NOTICE.

**Whittier
Wood**
FURNITURE

P.O. Box 2827
Eugene, OR 97402 USA



CALL US FIRST!

DO NOT RETURN ITEM TO STORE

Service Policy: We will replace any parts which are defective, missing or damaged during assembly. Please contact Whittier Wood Products customer service department directly (by phone, fax, mail or email) for replacement parts.

Hours: Our friendly customer service staff can be reached Monday-Friday 7:00 a.m. to 5:00 p.m. (Pacific Time). A message can be left 24 hours a day, 7 days a week.

To Order: Provide the complete furniture model number (upper left corner of this page), part letter/number, production code, quantity needed, reason for replacement and your full name and address along with a telephone number in case we need to contact you.

Parts ship from our Eugene, Oregon factory within 1 or 2 business days from the time we receive the request. Please allow 5-10 business days for delivery.

800-653-3336

Outside U.S. or Canada: 541-687-0213

Fax: 541-687-2060 • www.whittierwood.com

Mail: P.O. Box 2827 • Eugene, Oregon 97402, U.S.A.

IMPORTANT NOTES:

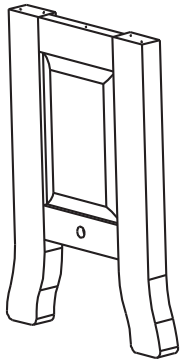
- Read both the Assembly Instructions and Finishing Hints completely before beginning.
- Store the parts: 1) in their box; 2) in a dry place; 3) in temperatures ranging from 40° to 90°. (Not on a cold, possibly damp, cement floor.)
- Inspect your furniture periodically for any loose glue joints or screws, or any other problem which may be affecting the stability of your furniture. Tighten or repair as needed.

Production Code:

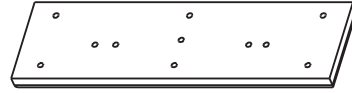
VN

5023W Portland Trestle Bench — Parts List

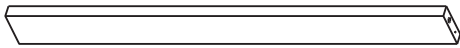
BEFORE BEGINNING ASSEMBLY, check that the quantities of the parts received match those on the parts list.



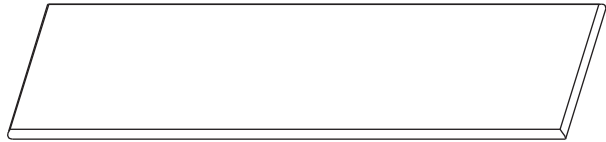
A — Leg — Qty. 2



B — Top Support — Qty. 2

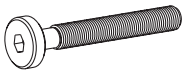


C — Middle Support — Qty. 1



D — Seat — Qty. 1

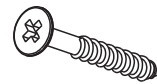
HARDWARE



E — 6x60mm
Hex Bolt — Qty. 2



F — Barrel Nut — Qty. 2



G — 4x38mm Phillips Screw
— Qty. 16



H — 10x30mm
Wood Dowel — Qty. 10



I — Wood Button — Qty. 2



J — Hex Wrench — Qty. 1

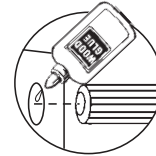
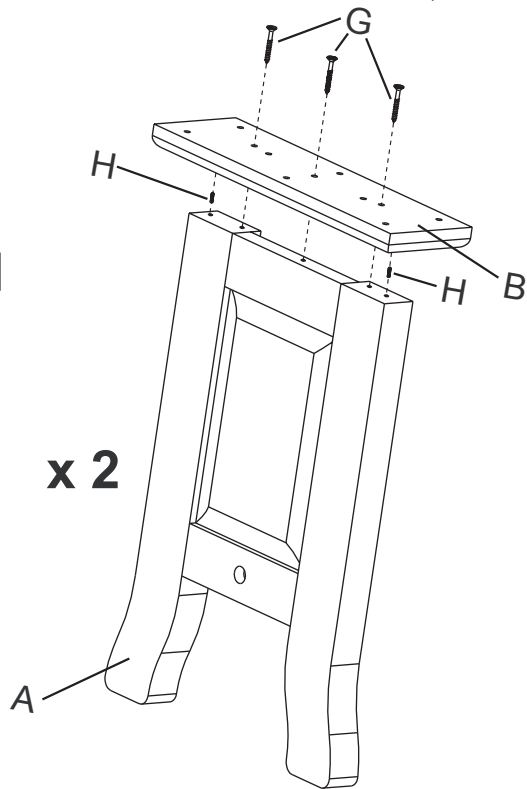
5023W Portland Trestle Bench

ASSEMBLY INSTRUCTIONS


TOOLS REQUIRED: Phillips Screwdriver, Mallet or Padded Hammer, Wood Glue, Slotted Screwdriver


STEP 1

Fig. 1



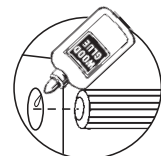
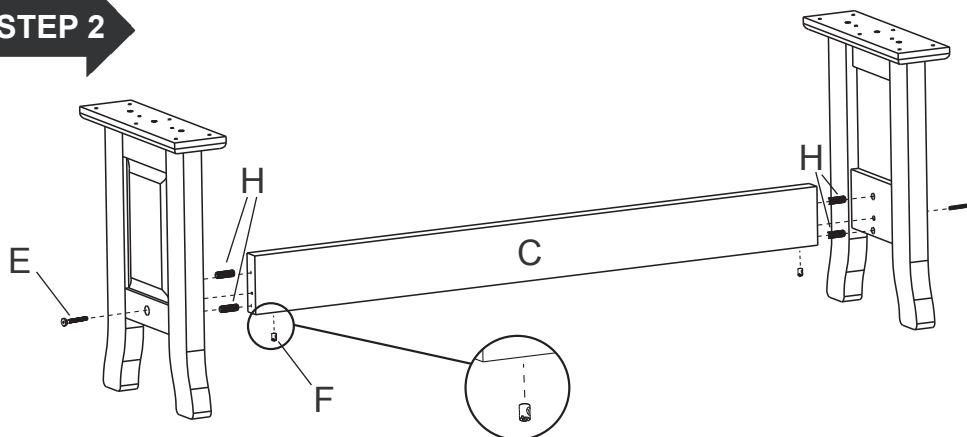
**GLUE ALL
DOWELS IN
THIS STEP**

G  x 6
4x38mm Phillips Screw

H  x 4
10x30mm Wood Dowel

1. Spread a thin film of glue in the dowel holes on the top end of each Leg (A). Insert Dowels (H) into these holes. Spread a thin film of glue into the dowel holes on the bottom of each Top Support (B). Place over dowels and secure to leg with 4x38mm Phillips Screws (G).

STEP 2



**GLUE ALL
DOWELS IN
THIS STEP**

E  x 2
6x60mm Hex Bolt

F  x 2
Barrel Nut

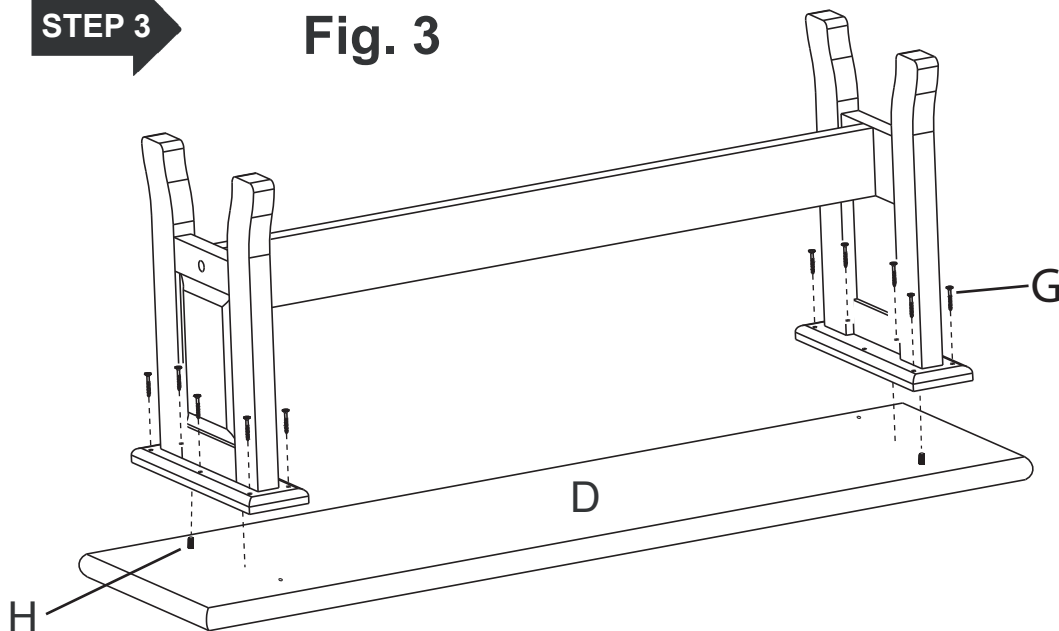
H  x 4
10x30mm Wood Dowel

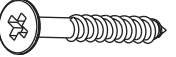

Fig. 2

2. Spread a thin film of glue in the dowel holes on both ends of Middle Support (C). Insert Dowels (H) into the holes. Spread a thin film of glue in the dowel holes on the inside face of each Leg (A). Fit dowels into holes and secure with 6x60mm Hex Bolts (E) and Barrel Nuts (F). NOTE: One end of the Barrel Nut is slotted to allow alignment with a slotted screwdriver. Insert Barrel Nuts into Middle Support so that this end points out.

STEP 3

Fig. 3



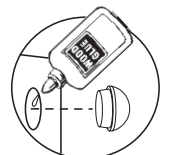
- G  x 10
4x38mm Phillips Screw
- H  x 2
10x30mm Wood Dowel

3. Place Seat (D) face down on a clean, protected surface. Insert a 10x30mm Wood Dowel (H) into two of the holes in the bottom side as shown in Fig. 3. Position the leg, top support, and middle support assembly so that the corresponding holes in the top supports fit over the dowels in the seat. Attach to seat with 4x38mm Phillips Screws (G) through holes in Top Supports (B).

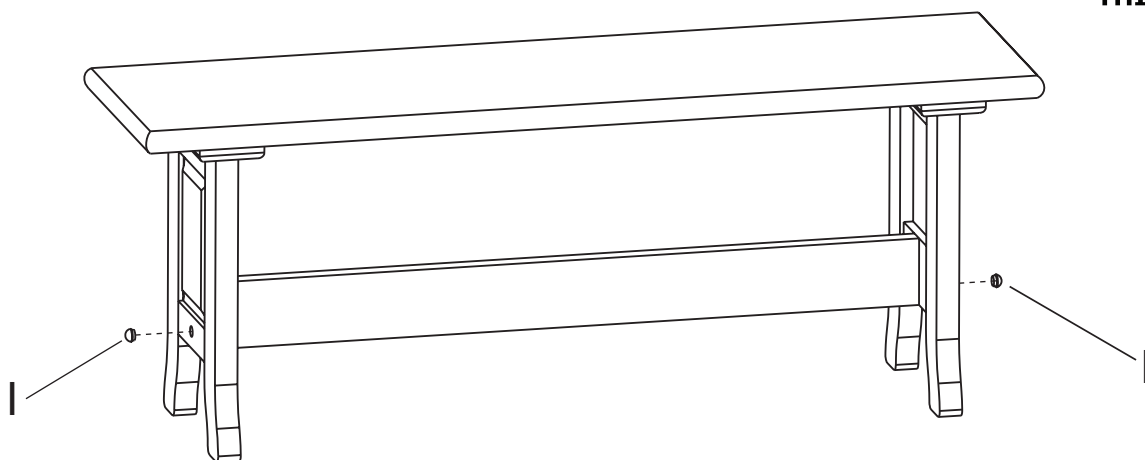
NOTE: There is no screw used in the holes directly under the middle support.

STEP 4

I  x 2



**GLUE ALL
BUTTONS IN
THIS STEP**



4. Spread a thin film of glue in the hole on the outside of each leg. Insert the tapered side of a Button (I) into each hole. Wipe off any excess glue with a damp rag.

Finishing Hints

Choosing the Finish:

1. Choose a finish that will meet your expectations for the product you are finishing. Are you matching existing furniture or do you want a “natural” finish? Is the piece to be functional, decorative or both? The answers to these questions may affect the type of finish you choose.
2. Use products of the same brand to ensure compatibility of products.
3. **ALWAYS** follow the stain manufacturer’s instructions. Pine is a porous wood and looks best when following the finishing instructions for softwoods.
4. We recommend using a wood conditioner under oil base stains.
5. Work in a well ventilated and well lit area.

Getting Started:

1. **Assembly Instructions may contain special finishing information for that item.** Read both the Assembly Instructions and these Finishing Hints completely before beginning.
2. Sand the entire piece, using #220 grit sandpaper. Sand with the grain of the wood on flat surfaces and opposite the grain on turnings. Some parts are plywood. Be careful not to sand through the veneer. End grain (table top ends, seat edges, grooves on turnings, etc.) accepts more stain. Extra sanding in these areas with a #320 grit sandpaper will reduce stain absorption, creating a more evenly stained piece.
3. When sanding is completed, wipe the surface of your furniture with a cloth or tack rag. Make sure the item is free of dust before proceeding.
4. For most products, we recommend preparing and staining the wood prior to assembly. Due to the assembly procedures for chairs, rockers and stools, we recommend assembling these items prior to finishing.
5. If you do choose to finish chairs, rockers or stools prior to assembly, it is **imperative** that you protect the ends of dowels and spindles, and the mortise holes where the wood is joined, from finishing products. Use masking tape around the ends, being careful to cover only the section that will be inserted (remove the tape after the finish has dried and before the furniture is assembled). Wood glue **will not bond** if finishing products are present. If you do get finishing product in these areas, it must be removed to ensure proper bonding.
6. If glue is used in assembly of your furniture, remove any excess glue spots or drips before finishing. Wood surfaces with glue **WILL NOT** accept stains, and will leave a light spot. To remove glue, wipe off as much as possible while wet, then lightly sand the surface until the remaining glue is removed.

Basic Equipment:

- Rubber gloves
- Rags
- Paper towels
- Q-tips
- Tack cloth
- Drop cloth
- Paint brushes (bristle and foam)
- #220 & #320 sandpaper
- Mineral spirits
- Masking Tape

Gluing Hints:

These are general hints. Refer to the instruction sheet for detailed information on gluing your specific product. Your unit may not need glue.

1. We **strongly** recommend that you first lay out all the parts and familiarize yourself with how they fit together before assembling with glue. Glue will set up quickly and can cause damage to the parts if you try to reposition any that have been assembled incorrectly.
2. Glue usually takes several hours to cure (or harden) but it will sometimes set up, or grab, in several seconds. Therefore, once you begin final assembly, be sure to proceed quickly and diligently.

Gluing Hints (cont.)

3. We recommend that you use a good wood glue, such as ***Elmer's Wood Glue*** or ***White Glue, Tite-bond Wood Glue*** or the equivalent; unless the instructions call for a special type such as a slow drying epoxy glue. Carefully read the glue manufacturer's label and follow all instructions.
4. Be sure the holes are clear of any dust so the glue will have a clean surface to adhere to. Blowing in the holes before gluing is recommended, ***but be sure to protect your eyes.***
5. ***Avoid getting glue on surfaces to be finished!*** Most stains or finishes will not penetrate where glue has been spilled. Wet glue can be wiped off with a damp cloth. Follow with a light sanding of the area to ensure a proper finish.
6. ***Do not over glue!*** It is important to apply an even coat inside all holes and slots. Use a small dowel or pencil to spread glue evenly around the inside of the holes. Because of the fit of the spindles or dowels in the holes, the spindle or dowel pushes glue to the bottom of the hole. If too much glue is used, it will fill the hole and not allow the spindle or dowel to go all the way in.

Staining:

1. Read and follow label directions. Stir stain well before starting.
2. Test stain on an inconspicuous spot on your project, or use the sample chip if one is provided. The sample chip must be sanded in the same way as your furniture kit to ensure the piece will accept the stain similarly. Put at least one coat of your top coat over the stain sample, as it also affects the look of the stain. ***Test every type of wood that is in your kit.*** Some of our products include more than one type of wood, which may react differently to the stain color. Sample chips for the different woods may be included. It may be necessary to add a second coat of stain to lighter woods to match the darker woods in your kit.
3. Apply stain with a poly brush or lint-free cloth. Apply stain over a small area and wipe off excess. Working in small areas will make the color easier to control.
4. Q-tips are ideal for hard to reach areas.
5. Allow to dry thoroughly before proceeding.

Applying the Top Coat:

No top coat is required if using paint.

1. ***Always read and follow all label directions.*** Stir your finish coat gently, ***do not shake.*** It will create bubbles that are hard to remove.
2. ***All surfaces*** (including the underside of table tops and inside drawers) ***must be sealed with at least one layer of a top coat.*** This will help minimize wood swelling, shrinkage, warping and cupping due to changes in moisture content or temperature.
3. We recommend that you ***apply a minimum of two coats when using polyurethane or varnish (especially on all table top and work surfaces).*** Sand lightly between coats using a #320 grit sandpaper or 00 steel wool for the smoothest possible finish.
4. Some water-based finishes tend to raise the grain slightly. This can be easily controlled with this sanding step. However, do not use steel wool when using water-based finishes. Strands of steel fiber caught in the wood can cause rust spots when coated with any water-based product.

Painting:

1. For best results when painting, first coat the wood with a primer. An oil based primer would be best for a smooth finish. If you do not wish to use a solvent based primer, a water based primer would work almost as well.
2. Buy a quality brand paint. You may use a satin, semi-gloss, or gloss sheen. Apply a second coat for a smooth finish. Lightly sand between coats using a #320 grit sandpaper, so that the second coat will bond well. Repeat as desired.
3. Since there is such a variation between paint manufacturers, refer to your paint supplier for specific advice on using the paint that you purchase.