

Table Tops

Assembly Instructions

Model #

546We

Oval Plank Extension 42" x 57"– 87"



Shown with 555W Legs
(Legs Sold Separately)

550We

Rectangular Butcher Block Extension
40" x 66"– 96"

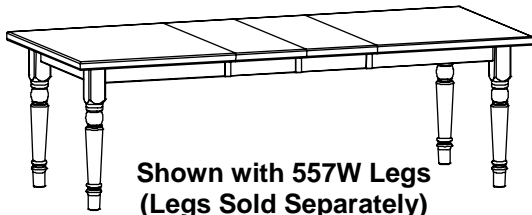

Shown with 557W Legs
(Legs Sold Separately)



IMPORTANT NOTES:

- For normal household use only. *Not* recommended for commercial use.
- Do not climb, sit or stand on this piece of furniture.
- Before you begin your project, completely read the Assembly Instructions and Finishing Hints.
- Store this item: 1- in its box; 2- in a dry place; 3- in temperatures that range from 40°F to 90°F (not on a cold and possibly damp cement floor).
- Periodically inspect your furniture for any loose glue joints, screws or any other problem that might affect the stability of your furniture. Tighten or repair as needed.

DESIGN SUBJECT TO CHANGE WITHOUT NOTICE.

Congratulations!

This fine piece of furniture will make a gorgeous addition to your home. For the best results, read the Assembly Instructions and Finishing Hints before you begin your project.



CALL US FIRST! Do not return this item to the store

Service Policy: We will replace any part that is defective, missing or damaged during assembly. For a replacement part, directly contact Whittier Wood Products customer service department by phone, fax, mail or email.

Hours: Our friendly customer service staff can be reached Monday-Friday 7:00 a.m. to 5:00 p.m. (Pacific Time). You may leave a message 24 hours a day, seven days a week.

To Order: Provide the furniture model number (upper portion of this page), the part letter, production code, quantity needed, reason for replacement and your full name, address and telephone number.

Parts ship from our Eugene, Oregon factory within one or two business days from the time we receive your request. Please allow five to ten business days for delivery.

800-653-3336 • Outside the U.S. or Canada: 541-687-0213 • Fax: 541-687-2060
www.whittierwood.com • P.O. Box 2827 • Eugene, Oregon 97402, U.S.A.

**Whittier
Wood**
FURNITURE

P.O. Box 2827
Eugene, OR 97402 USA

Production Code:











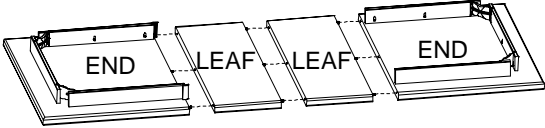
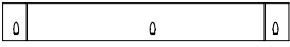
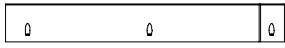
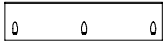
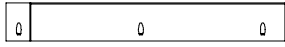
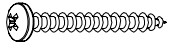

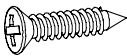
VN

08/12

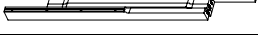
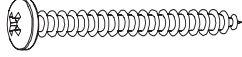
**546We Oval Plank Extension 42" x 57" – 87" ;
550We Rectangular Butcher Block Extension 40" x 66" – 96"**

Parts List

Please identify the parts and check that quantities received match those on this list.
If you need to replace a part, refer to the following letter and part name.

Part	Description	Quantity	
		546We	550We
Ac	Table Top (End – Qty. 2; Leaf – Qty. 2) <i>Slides removed for illustration purposes</i> 	1	1
Dc	End Apron (attached) 	2	2
Ec	Left Front/Back Apron (attached) 	2	2
Fc	Leaf Apron 	4	4
Gc	Right Front/Back Apron (attached) 	2	2
H	#8 x 1-1/4" Pan Head Screw 	30 (18 inserted)	30 (18 inserted)
I	Brass Angle Brace 	4	4
J	#10 x 3/4" Brass Oval Head Screw 	8	8
K	Lever Lock 	6	6
Ld	#8 x 5/8" Flat Head Screw 	40 (16 inserted)	40 (16 inserted)
M	Leveler Plate 	6	6
N	Guide Pin 	9	9
O	Table Slide (attached) 	2	2
P	#12 x 1-3/4" Pan Head Screw (inserted) 	12	16
Q	Leg Bracket (attached) 	4	4
S	Apron Cap (attached) 	6	6
T	90 Deg. Bracket (attached) 	6	6
U	#6 x 5/16" Flat Head Screw (inserted) 	12	12
V	#6 x 3/4" Brass Flat Head Screw (inserted) 	12	12

550 shown in the illustrations.

**546We Oval Plank Extension 42" x 57" – 87" ;
550We Rectangular Butcher Block Extension 40" x 66" – 96"**
Assembly Instructions

Tools Required: Philip Screwdriver, Wood Glue

SPECIAL INSTRUCTIONS: If a leaf panel cups, do not be alarmed. It is a natural characteristic of unfinished wood to cup from uneven moisture conditions. The image below shows an exaggerated view of what could happen. This only means that the **convex side has absorbed moisture** or the **concave side has dried out**. Usually a cupped panel will straighten out if both sides are exposed to similar conditions for a day or so.

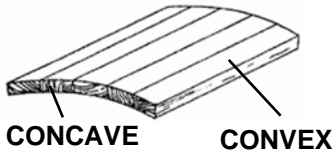

- Place the Table Top and the Leaves (Ac) face down on a clean protected surface. Make sure that the arrows stamped on the table ends and leaves face each other. Pull sections slightly apart and glue Guide Pins (N) into the predrilled holes. Make sure that the pins all face the same direction. See Figure 1.

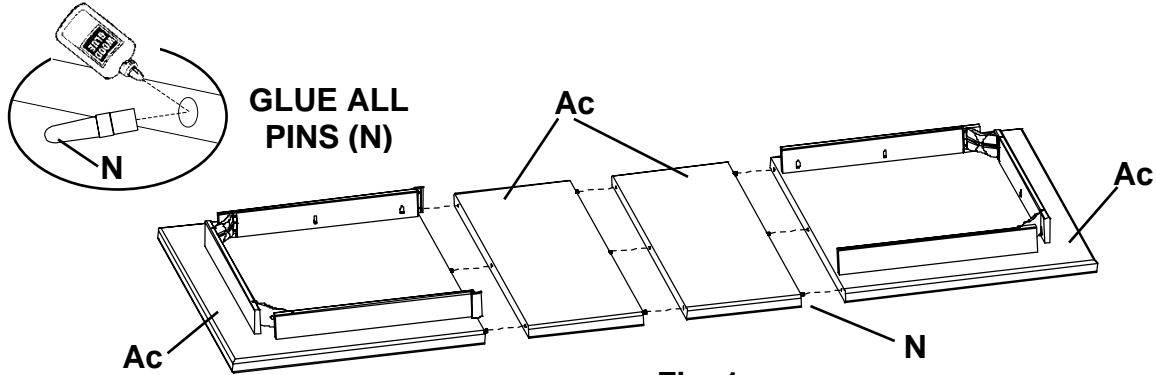
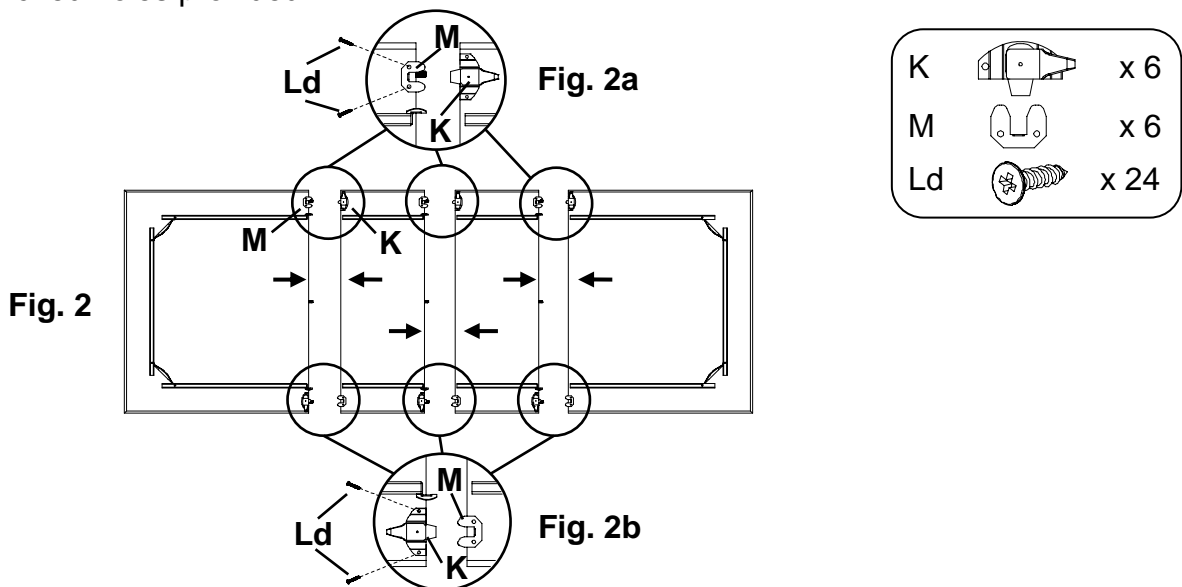



Fig. 1

- Use the pre-punched holes as guides and place the Lever Locks (K) in place as shown in Figures 2, 2a, and 2b. The locks will face in opposite directions on each side of the table. Fasten the Lever Locks in place using #8 x 5/8" Flat Head Screws (Ld). Close the table. Slide the Lever Plates (M) into the Lever Locks (K) and fasten with #8 x 5/8" Flat Head Screws (Ld) in the pre-punched holes provided.



**546We Oval Plank Extension 42" x 57" – 87" ;
550We Rectangular Butcher Block Extension 40" x 66" – 96"**
Assembly Instructions

3. To help position the Leaf Aprons (Fc) in their proper locations, the leaves and leaf aprons have been stamped with matching letters (A/A, B/B, C/C, D/D). See Figures 3 and 3a. Insert three #8 x 1-1/4" Pan Head Screw (H) through the pocket drilled holes in the Leaf Apron (Fc) and into the predrilled holes in the Leaf (Ac) and fasten securely. To increase support of the leaf aprons, fasten a Brass Angle Brace (I) just to the left or right of the center hole of the aprons using two #10 x 3/4" Brass Oval Head Screws (J) in each Angle Brace. See Figure 3a.

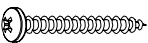
I		x 4
J		x 8
H		x 12

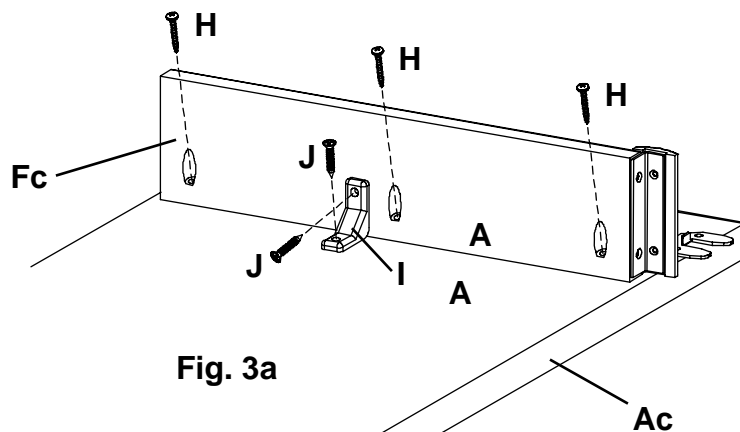
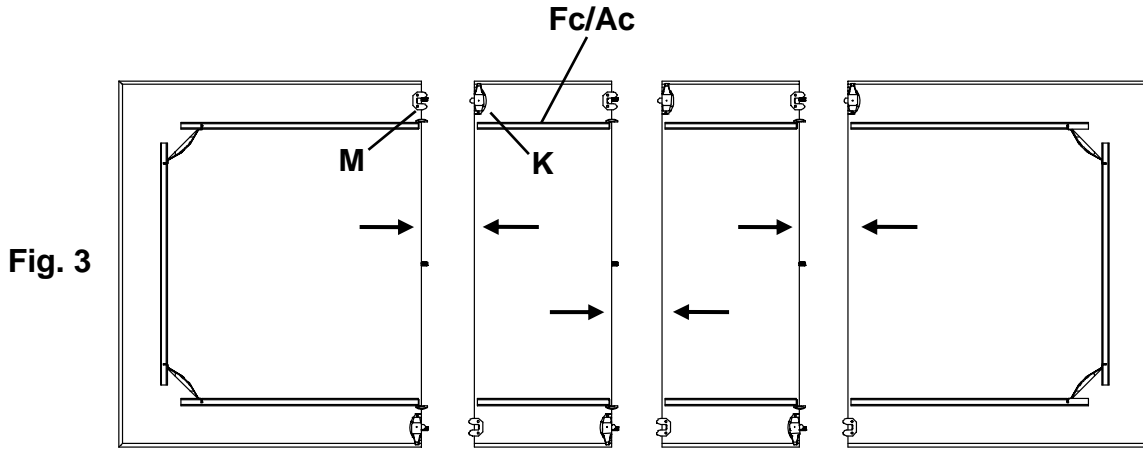

Whittier Finishing Hints

Checklist of materials

- | | | |
|---|--|--|
| <input type="checkbox"/> Rubber gloves | <input type="checkbox"/> Tack cloth | <input type="checkbox"/> #220 & #320 sandpaper |
| <input type="checkbox"/> Lint-free rags | <input type="checkbox"/> Drop cloth | <input type="checkbox"/> Painter's tape |
| <input type="checkbox"/> Paper towels | <input type="checkbox"/> Stain brushes (poly bristle and foam) | <input type="checkbox"/> Wood glue |
| <input type="checkbox"/> Cotton swabs | | |

Getting started

Assembly Instructions may contain special finishing information or gluing requirements for that item.

Completely read both the Assembly Instructions and these Finishing Hints before you begin your project.

Choosing the finish: Ask your retailer for advice on how to finish bare wood. Choose a finish that meets your expectations for the end use of the product. Will you use it as a work surface as on a desk or kitchen island? Are you matching a finish on existing furniture? The answers to these questions may affect the type of finish you choose.

Where to work: Choose an area that has good light and is well ventilated, warm and dry. If the work area is cold and damp, the wood finishing products may require a longer drying time than the labels indicate. Do not work in a dirty or dusty area – dirt and/or dust can embed in the finish.

Gluing hints

These are general hints. Refer to the Assembly Instructions for detailed information on how to glue your specific product. Use wood glue such as Elmer's Wood Glue, Titebond Wood Glue or the equivalent. Some instructions call for a slow drying epoxy glue. Carefully read the label and instructions of the glue manufacturer. Your unit may not need glue.

1. We strongly recommend that you lay out all the parts and familiarize yourself with how they fit together before assembling with glue. Glue will set up quickly. You can damage parts if you try to reposition any that have been assembled incorrectly.

2. For glue to properly bond, it is very important to apply the wood glue to bare wood. Protect your eyes and blow into holes to clear excess dust. This will help the glue to adhere to a clean surface.
3. If you plan on finishing the product before you assemble it, place painter's tape three-fourths of the way up from the end of a dowel, spindle or tenon. This protects the ends from the finishing product but allows finish application where it will be visible. Finishing products inhibit the bonding properties of wood glue. Remove the tape prior to the final assembly.
4. Avoid getting glue on surfaces to be finished. Most stains or finishes will not penetrate where glue has been spilled. Wet glue can be wiped off with a damp cloth. Follow with a light sanding of the area to ensure a proper finish.
5. It is important to apply an even coat inside holes and slots. Use a small dowel, pencil or cotton swab to spread glue evenly around the inside of the holes. Do not over glue. The tight fit of the spindles or dowels in the holes can cause glue to be pushed to the bottom of the hole. If too much glue is used it will fill the holes and not allow the spindle or dowel to be fully inserted.
6. Glue usually takes several hours to cure or harden but it will set up or grab in several seconds. Once you begin final assembly, proceed quickly.

Finishing hints

1. Use products of the same brand to ensure compatibility. It is not recommended to mix solvent based and water based finishes. *Always read and follow all label directions on the can.*
2. Alder is a porous hardwood and often looks best when following the finishing instructions for softwoods.
3. Use a wood conditioner under oil base stains.

Preparing the surface

1. Sand each piece with #220 grit sandpaper. Sand with the grain of the wood on flat surfaces and opposite the grain on turnings. Some parts may be plywood. Be careful not to sand through the veneer. End grain such as table top ends, seat edges and grooves on turnings accept more stain. Extra sanding in these areas with #320 grit sandpaper reduces stain absorption and creates a more evenly stained piece.
2. When sanding is completed, wipe the surface of your furniture with a lint-free rag or tack cloth. Make sure the item is free of dust before you proceed.

Staining

1. Read and follow label directions. Stir the stain well before you start. Stir periodically throughout the duration of the project to maintain uniform color consistency.
2. Test stain on an inconspicuous spot on your project. Put at least one coat of your top coat over the test area as it also affects the look of the stain. *Test every type of wood that is in your kit. These are identified in the Assembly Instructions.* Different types of wood may react differently to the stain color. You might need to add a second coat of stain to lighter woods to match the darker woods in your kit.
3. Apply stain with a poly brush or lint-free cloth. Apply stain over a small area and wipe off excess. Working in small areas will make the color easier to control.
4. Cotton swabs are ideal for hard to reach areas.
5. Allow the stain to dry thoroughly before you proceed.

Applying the top coat

1. *Always read and follow all label directions.* Stir your top coat gently; do not shake. Shaking the can creates bubbles that are hard to remove.
2. All surfaces including the underside of table tops and inside drawers must be sealed with at least one layer of a top coat. This will help minimize wood swelling, shrinkage, warping and cupping due to changes in moisture content or temperature.

3. Apply a minimum of two coats when you use polyurethane or varnish (especially on all table top and work surfaces). After allowing the first coat to dry, sand lightly with #320 grit sandpaper. Remove dust with a lint-free rag or tack cloth. For added protection, apply additional coats. Lightly sand and wipe surface with a lint-free rag or tack cloth between coats.
4. Some finishes tend to slightly raise the grain. This can be easily controlled with a light sanding between coats. Do not use steel wool when you use water-based finishes. Strands of steel fiber caught in the wood can cause rust spots when coated with any water-based product.

Painting

1. Since there is a large variation between paint manufacturers and products, ask your paint supplier for specific advice on how to best use the paint you purchase. Ask them specifically for advice on finishing bare wood.
2. First coat the wood with a primer. An oil based primer works best for a smooth finish. If you do not wish to use a solvent based primer, water based primer works almost as well. However it may raise the wood grain and require additional sanding.
3. Buy quality brand paint in a satin, semi-gloss, or gloss sheen. Apply a second coat for a smooth finish. Lightly sand between coats using with #320 grit sandpaper so that the second coat will bond well. Be sure to use a tack cloth after sanding to remove any residue. Repeat as desired.
4. No top coat is required when using paint.