

McKenzie Twin Storage Beds

AFGAC = Glazed Antique Cherry finish

AFCFAF = Caffè finish

Assembly Instructions

Model #

1300AFGACa;

1300AFCFAFa

McKenzie

Twin Storage

Bed

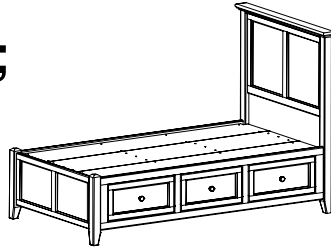

Model #

1359AFGACc;

1359AFCFAFc

McKenzie

Twin Bookcase

Storage Bed

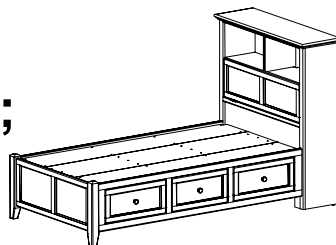

IMPORTANT NOTES:

- For normal household use only. *Not* recommended for commercial use.
- Remove items before you move this unit.
- Do not overload the drawers.
- Before you load or move this unit, tighten all screws and supports.
- Before you begin your project, completely read the Assembly Instructions.
- Store this item: 1- in its box; 2- in a dry place; 3- in temperatures that range from 40°F to 90°F (not on a cold and possibly damp cement floor).
- Periodically inspect your furniture for any loose glue joints, screws or any other problem that might affect the stability of your furniture. Tighten or repair as needed.
- This assembly requires two people.

DESIGN SUBJECT TO CHANGE WITHOUT NOTICE.

Congratulations!

This fine piece of furniture will make a gorgeous addition to your home. For the best results, read the Assembly Instructions before you begin your project.



CALL US FIRST! *Do not return this item to the store*

Service Policy: We will replace any part that is defective, missing or damaged during assembly. For a replacement part, directly contact Whittier Wood Products customer service department by phone, fax, mail or email.

Hours: Our friendly customer service staff can be reached Monday-Friday 7:00 a.m. to 5:00 p.m. (Pacific Time). You may leave a message 24 hours a day, seven days a week.

To Order: Provide the finish and furniture model number (upper portion of this page), the part letter, production code, quantity needed, reason for replacement and your full name, address and telephone number.

Parts ship from our Eugene, Oregon factory within one or two business days from the time we receive your request. Please allow five to ten business days for delivery.

800-653-3336 • Outside the U.S. or Canada: 541-687-0213 • Fax: 541-687-2060

www.whittierwood.com • P.O. Box 2827 • Eugene, Oregon 97402, U.S.A.

Whittier
Wood
FURNITURE

P.O. Box 2827
Eugene, OR 97402 USA

Production Code:













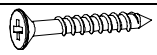

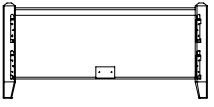
VN

11/12

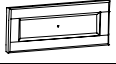
**1300AFGACa; 1300AFCAFa McKenzie Twin Storage Bed;
1359AFGACc; 1359AFCAFc McKenzie Twin Bookcase Storage Bed**
Parts List

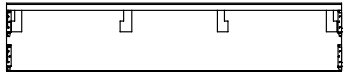
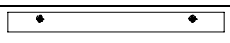
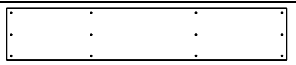

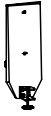







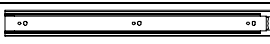

Please identify the parts and check that quantities received match those on this list.
If you need to replace a part, refer to the following letter and part name.

**1301AFGACa; 1301AFCAFa
Footboard, Pedestal and Side Panel Kit (x1)**

Part	Description	Quantity
B	Left Bracket (attached) 	6
C	Right Bracket (attached) 	6
D	#8 x 1" Black Screw (inserted) 	48
I	#8 x 7/8" Lo-Profile Screw (inserted) 	16
V	#8 x 1-1/4" Black Screw (inserted) 	60 (40 inserted)
YB	Footboard Assembly 	1
YC	Pedestal Kit 	1
YD	Small Drawer Box (assembled) 	1
YE	Large Drawer Box (assembled) 	2
YF	Small Drawer Face (attached) 	1
YG	Large Drawer Face (attached) 	2
YH	Side Panel 	1
YI	Trestle with T-Nuts 	4
YJ	Center Deckboard 	1
YK	Notched Deckboard (not attached) 	1
YL	Attached Deckboard (attached to pedestal) 	1
YM	Foot Assembly 	2
YN	Foot Bracket (attached) 	2
YO	Adjustable Glide (installed) 	2

**1300AFGACa; 1300AFCAFa McKenzie Twin Storage Bed;
1359AFGACc; 1359AFCAFc McKenzie Twin Bookcase Storage Bed**

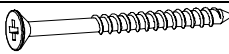

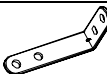

Parts List

Part	Description	Quantity
YP	Knob (attached) 	3
YQ	#8 x 1-1/2" Machine Screw (installed) 	3
YR	Drawer Slides (pre-installed sets) 	3
YS	#6 x 1/2" Philtruss Screw 	26 (18 inserted)
YT	#6 x 3/4" Philtruss Screw (inserted) 	18
YU	1/4" x 1-3/4" Hex Bolt 	8
YV	Washer 	8
YW	90° Bracket (2 holes) 	2
YY	Insert Nut (inserted) 	6
YZ	T-Nut (inserted) 	8
ZA	#8 x 1-5/8" Black Screw (inserted) 	18
ZB	#8 x 2" Black Screw (inserted) 	16
ZC	#8 x 20mm Pan Head Screw (inserted) 	8
ZG	90° Bracket (4 holes) 	1

Please note this Assembly Instruction is for either the Twin Storage Bed or the Twin Bookcase Storage Bed. The Parts list for each headboard follows on pages 4 and 5.

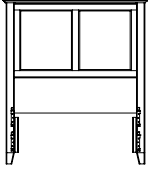
**1300AFGACa; 1300AFCAFa McKenzie Twin Storage Bed;
 1359AFGACc; 1359AFCAFc McKenzie Twin Bookcase Storage Bed**
Parts List

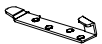

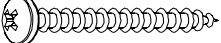







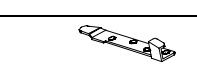
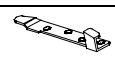
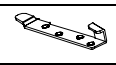
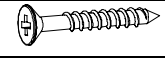
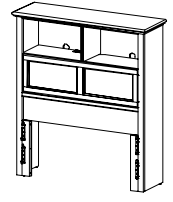
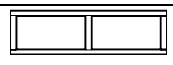

1302AFGAC; 1302AFCAF Twin Headboard Kit (x1)

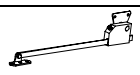
Part	Description	Quantity
A	Headboard Assembly 	1
B	Left Bracket (attached) 	2
C	Right Bracket (attached) 	2
D	#8 x 1" Black Screw (inserted) 	16
ZD	#12 x 2-1/2" Pan Head Screw (inserted) 	6

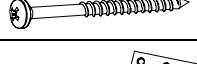
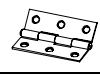
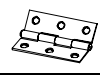

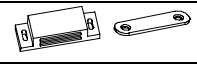
**1300AFGACa; 1300AFCAFa McKenzie Twin Storage Bed;
1359AFGACc; 1359AFCAFc McKenzie Twin Bookcase Storage Bed**

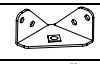
Parts List

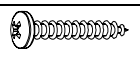
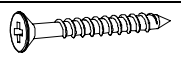
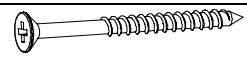
**1361AFGACc; 1361AFCAFc
Bookcase Headboard Kit (x1)**

Part	Description		Quantity
B	Left Bracket (attached)		2
C	Right Bracket (attached)		2
D	#8 x 1" Black Screw (inserted)		16
Ec	Bookcase Headboard Assembly		1
F	Assembled Door (attached)		1
G	False Bottom		2
H	Power Strip (installed)		1
I	#8 x 7/8" Lo-Profile Screw (inserted)		4
J	Wire Clip Screw (attached)		3
K	Door Stay (attached)		1
L	#6 x 5/8" Undercut Screw (inserted)		8
M	Door Stay Support (attached)		1
N	#6 x 1-1/4" Black Pan Head Screw (inserted)		3
O	Hinge (installed)		3 (AFGAC) 0 (AFCAF)
Oc	Hinge (installed)		0 (AFGAC) 3 (AFCAF)
P	#6 x 5/8" Flat Head Screw (inserted)		18
Q	Magnetic Catch Kit (attached)		2 sets
R	#6 x 5/8" Philtruss Screw (inserted)		9
S	Corner Brace (attached)		2
T	Large Adjustable Glide (installed)		2
U	#8 x 5/8" Pan Head Screw (inserted)		8
V	#8 x 1-1/4" Black Screw (inserted)		7
W	#8 x 2-1/4" Black Screw (inserted)		6

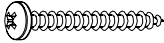
**1300AFGACa; 1300AFCAFa McKenzie Twin Storage Bed;
1359AFGACc; 1359AFCAFc McKenzie Twin Bookcase Storage Bed**
Parts List

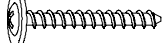
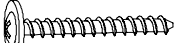
Part	Description		Quantity
X	#8 x 1-1/4" Pan Head Screw (inserted)		12
XA	Top Assembly (attached)		1
YA	Tack Glide (attached)		4
ZH	#8 x 1-1/8" Lo-Profile Screw (inserted)		6
ZI	#8 x 1-3/8" Lo-Profile Screw (inserted)		12

**1300AFGACa; 1300AFCAFa McKenzie Twin Storage Bed;
1359AFGACc; 1359AFCAFc McKenzie Twin Bookcase Storage Bed**
Assembly Instructions



This assembly requires two people.

Tools Required: Phillips screwdriver, Slotted Screwdriver, 7/16" open end or box end wrench.

1. Remove the Foot Assemblies (YM) from the back of the Footboard (YB) as seen in Figure 1 and place them off to the side.

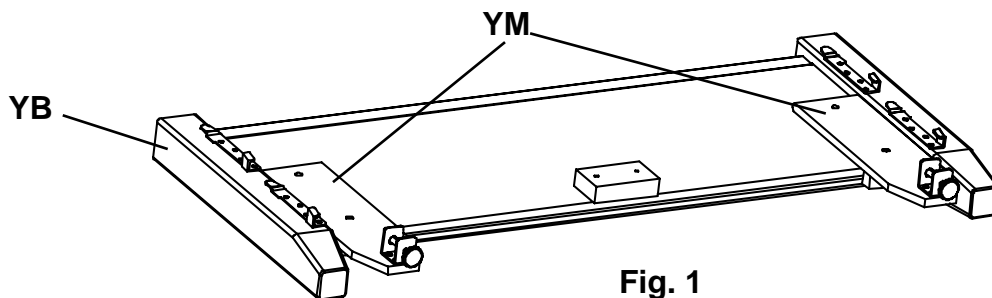

Fig. 1

2. The orientation of the drawer opening will be based on facing the backside of the footboard. Decide if you want the drawers to open on the left side or the right side of the bed. Figure 2 below shows the drawers opening on the right side. If you want the drawers to open on the left side, move the Footboard (YB) to the opposite end of the Pedestal Kit (YC). To attach the Footboard (YB) to the Pedestal Kit (YC), align the brackets and slide the Pedestal Kit down on to the Footboard (YB). See Figures 2 and 2a.

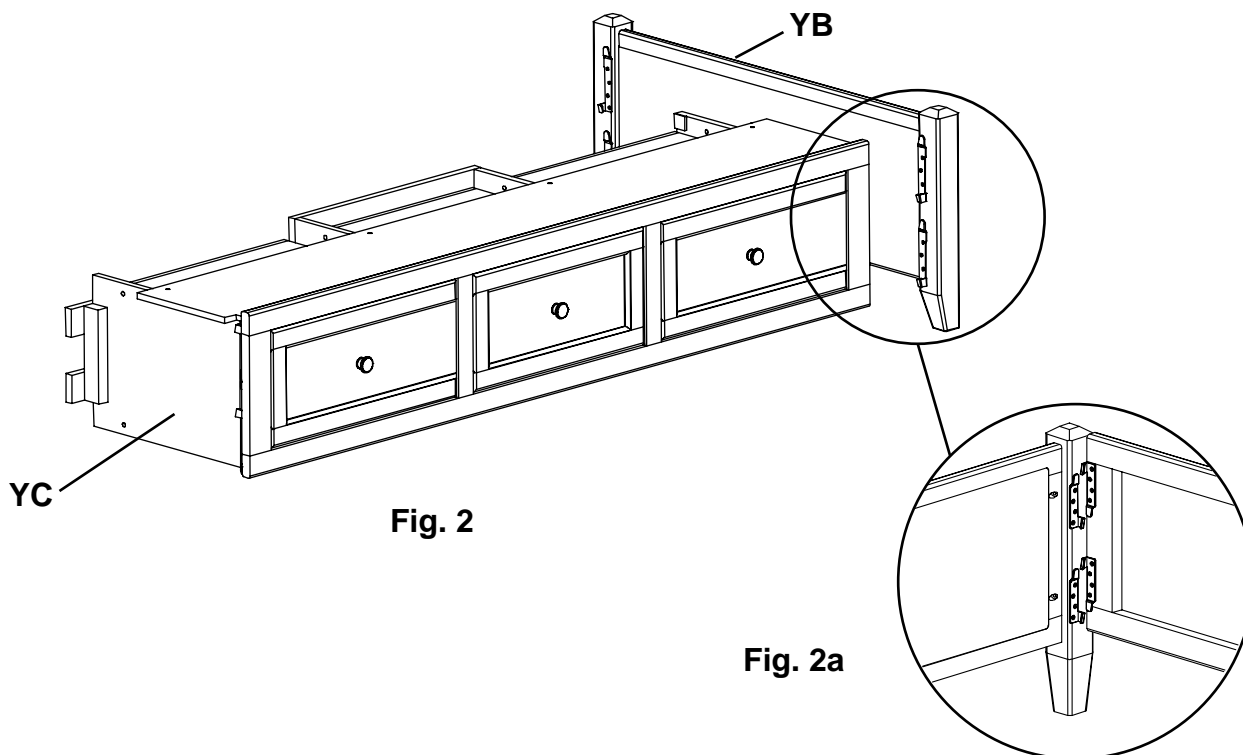
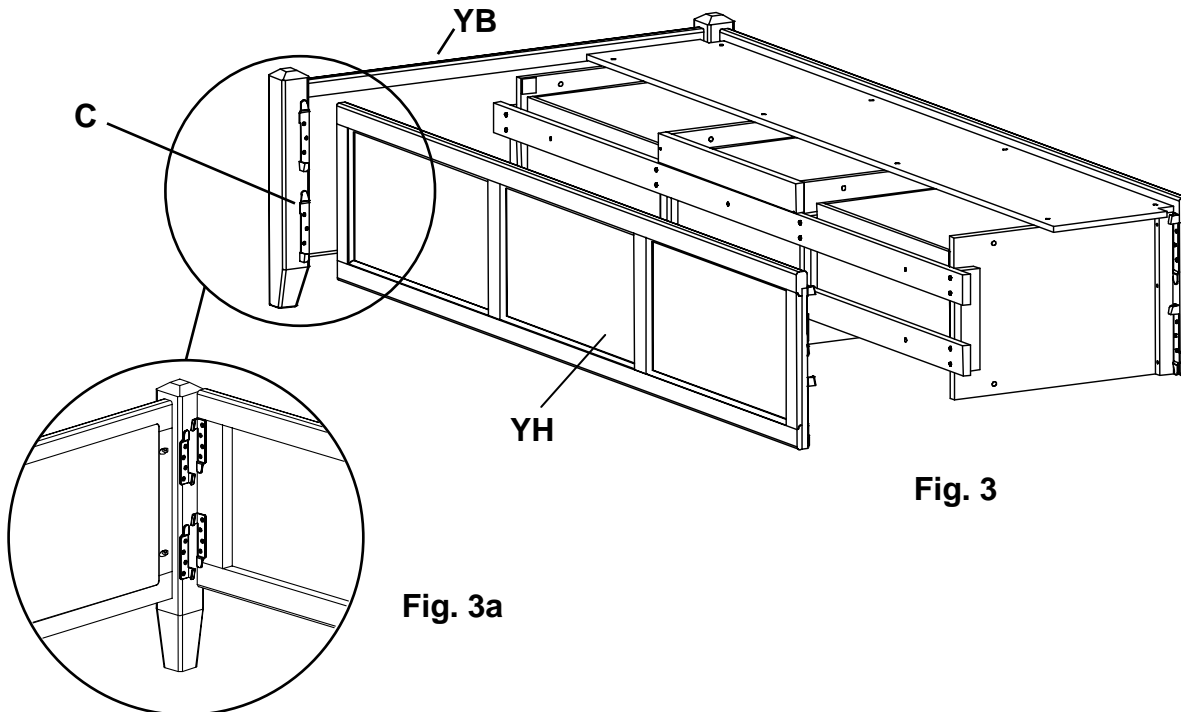

Fig. 2

Fig. 2a

**1300AFGACa; 1300AFCAFa McKenzie Twin Storage Bed;
1359AFGACc; 1359AFCAFc McKenzie Twin Bookcase Storage Bed**
Assembly Instructions

3. To attach the Side Panel (YH) to the Footboard (YB), align the brackets and slide the Side Panel (YH) down on to the Footboard (YB). See Figures 3 and 3a.



4. Move your Twin Headboard (A) or Twin Bookcase Headboard (Ec) into position. Make sure the drawers are opening on the side you desire. If you are satisfied, align and slide the brackets of the Bed Assembly on to the brackets of the Headboard (A or Ec). If you are not satisfied with the drawer position, remove the Footboard (YB) from the Bed Assembly and install at the opposite end. Attach the Headboard (A or Ec). See Figures 4 or 4a.

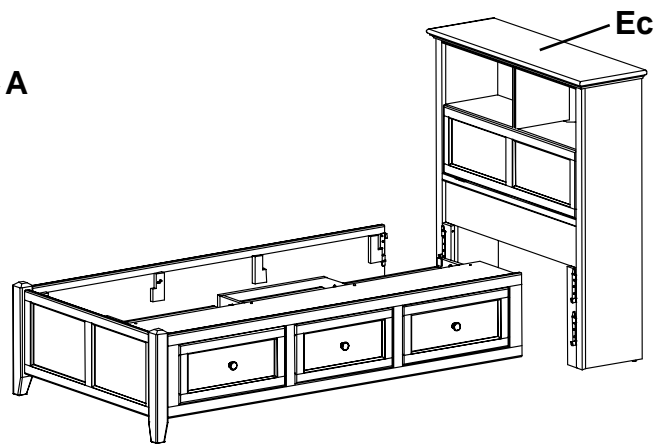
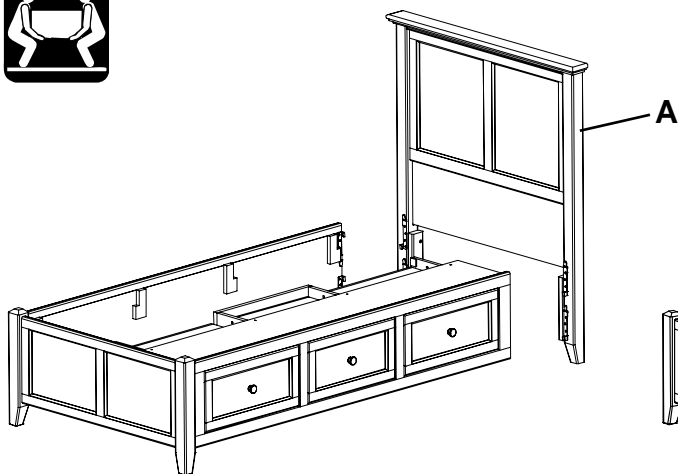

**1300AFGACa; 1300AFCAFa McKenzie Twin Storage Bed;
1359AFGACc; 1359AFCAFc McKenzie Twin Bookcase Storage Bed**
Assembly Instructions

5. Place one end of a Trestle with T-Nuts (YI) facing towards the Headboard, behind the rib in the pedestal closest to the Headboard. Place the other end of the Trestle into the notched bracket in the Side Panel (YH). See Figure 5. Place a Washer (YV) onto a 1/4" x 1-3/4" (YU) and insert through the holes in the rib and Trestle as seen in Figure 5a, threading into the T-Nut. Repeat for a second Trestle with T-Nuts (YI).

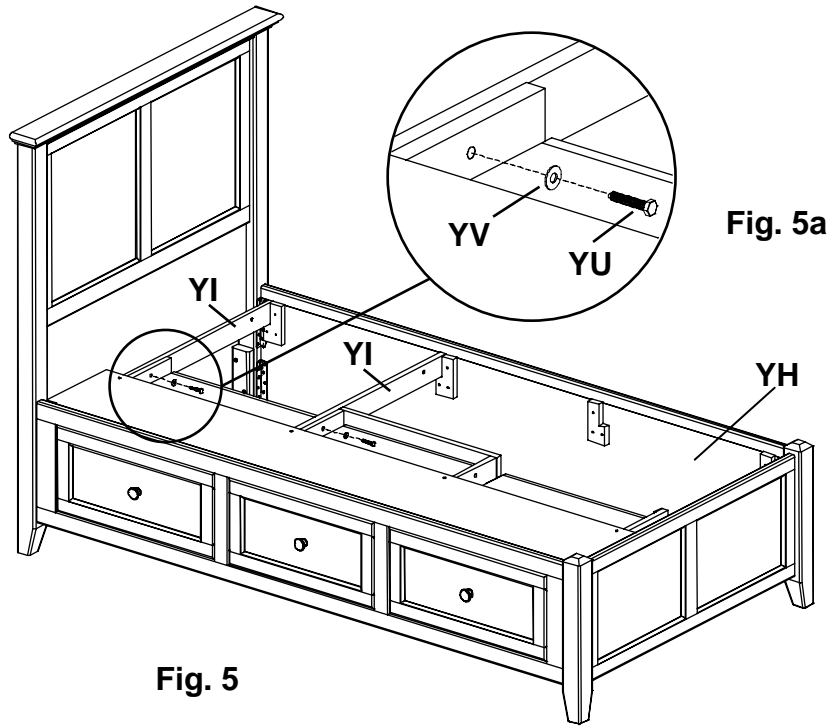





YU		x 2
YV		x 2

Fig. 5a

6. Attach two more Trestles with T-Nuts (YI) that face the Footboard (YB) as seen in Figure 6 and 6a.



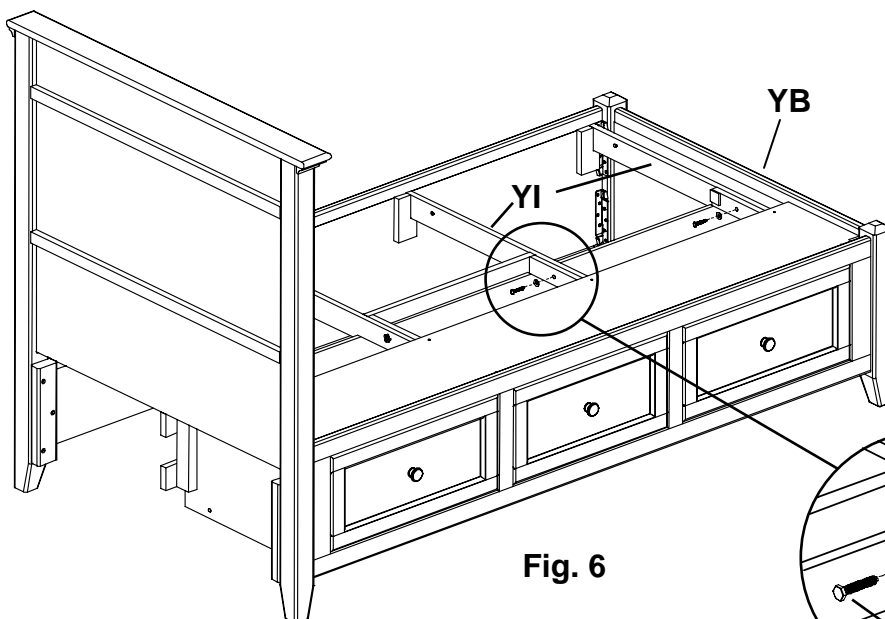

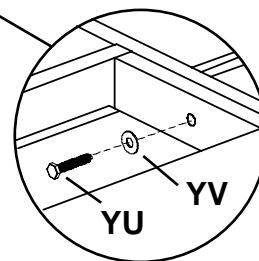
YU		x 2
YV		x 2



**1300AFGACa; 1300AFCAFa McKenzie Twin Storage Bed;
1359AFGACc; 1359AFCAFc McKenzie Twin Bookcase Storage Bed**
Assembly Instructions

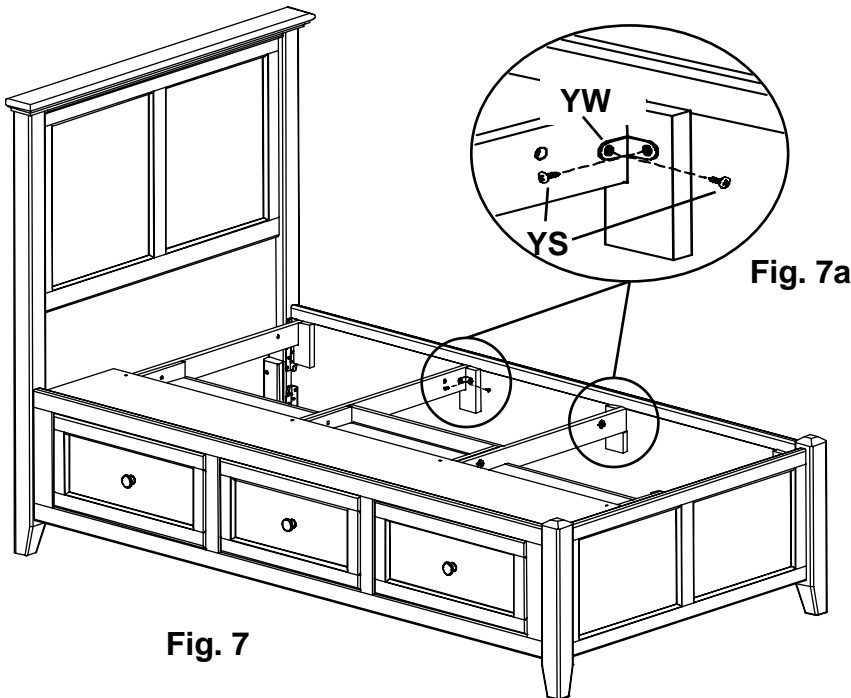

7. Using the 90° brackets with two holes (YW) attach the two middle Trestles to the notched brackets in the Side Panel (YH) with four #6 x 1/2" Philtruss Screws (YS). See Figures 7 and 7a.

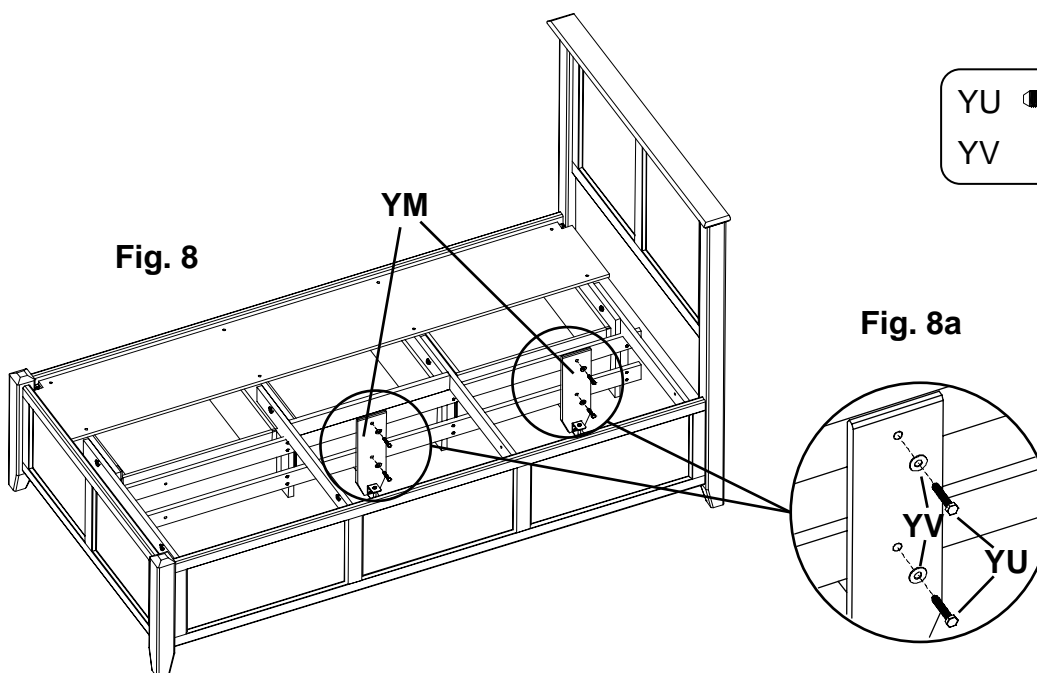

YW		x 2
YS		x 4

8. Locate the holes and T-nuts in the horizontal stretchers of the Pedestal Assembly. In the sets of stretcher holes nearest the Headboard, attach the two Foot Assemblies (YM) to the stretchers using four 1/4" x 1-3/4" (YU) and four Washers (YV). See Figure 8 and 8a.



YU		x 4
YV		x 4

**1300AFGACa; 1300AFCAFa McKenzie Twin Storage Bed;
1359AFGACc; 1359AFCAFc McKenzie Twin Bookcase Storage Bed**
Assembly Instructions

9. Facing the Footboard, attach the lower brace of the Pedestal Assembly to the Footboard with the 90° bracket with four holes (ZG) and four #6 x 1/2" Philtruss Screws (YS). See Figures 9 and 9a.

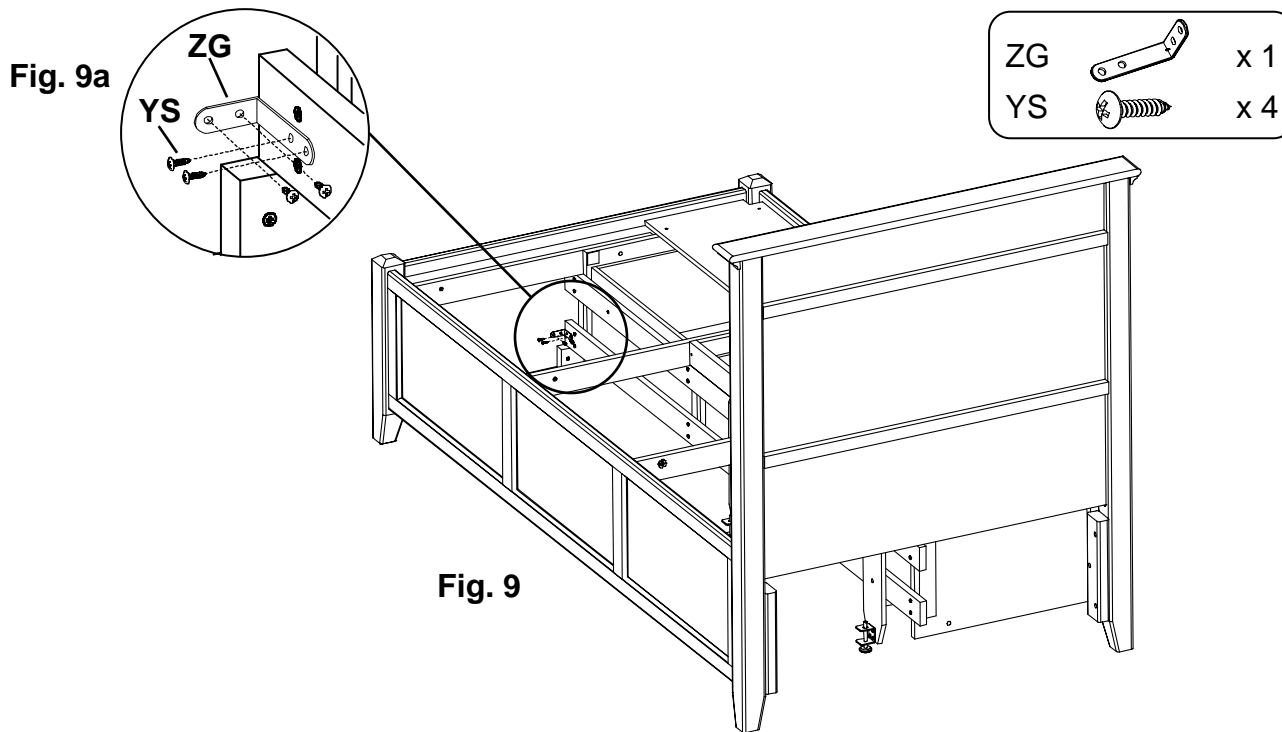

10. Move the Bed Assembly to its final destination. Adjust the Glides (YO) in the bottoms of the Foot Assemblies (YM) so that they touch the floor and bear weight. See Figure 10.

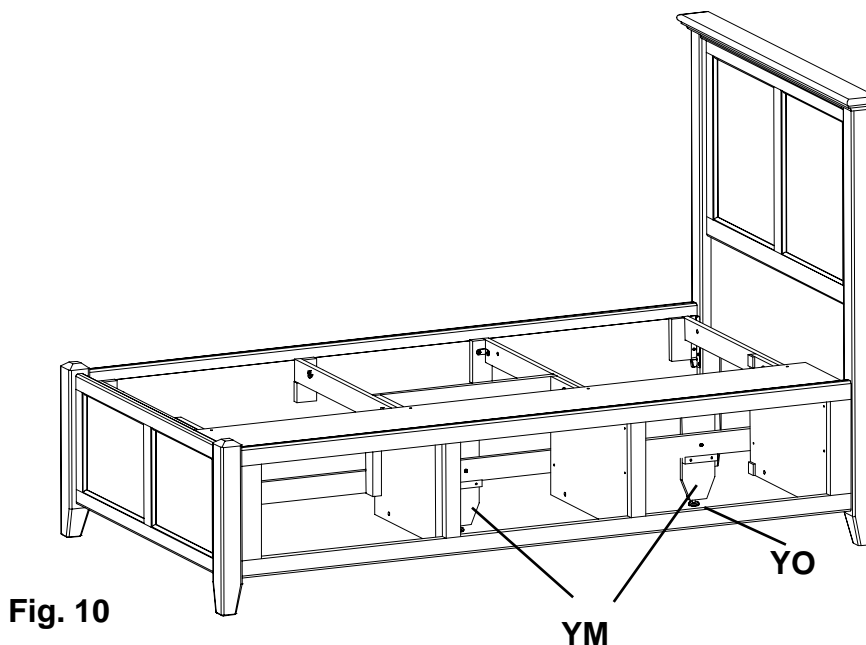

**1300AFGACa; 1300AFCAFa McKenzie Twin Storage Bed;
1359AFGACc; 1359AFCAFc McKenzie Twin Bookcase Storage Bed**
Assembly Instructions

11. If you have a Bookcase Headboard, stand in the open area of the assembly and reach behind the bookcase front legs to find the Large Adjustable Glides (T). Using a slotted screw driver, rotate the Large Adjustable Glides (T) clockwise until they bear weight. See Figures 11, 11a and 11b.

This is important if the bookcase headboard sits upon a carpet tack strip.

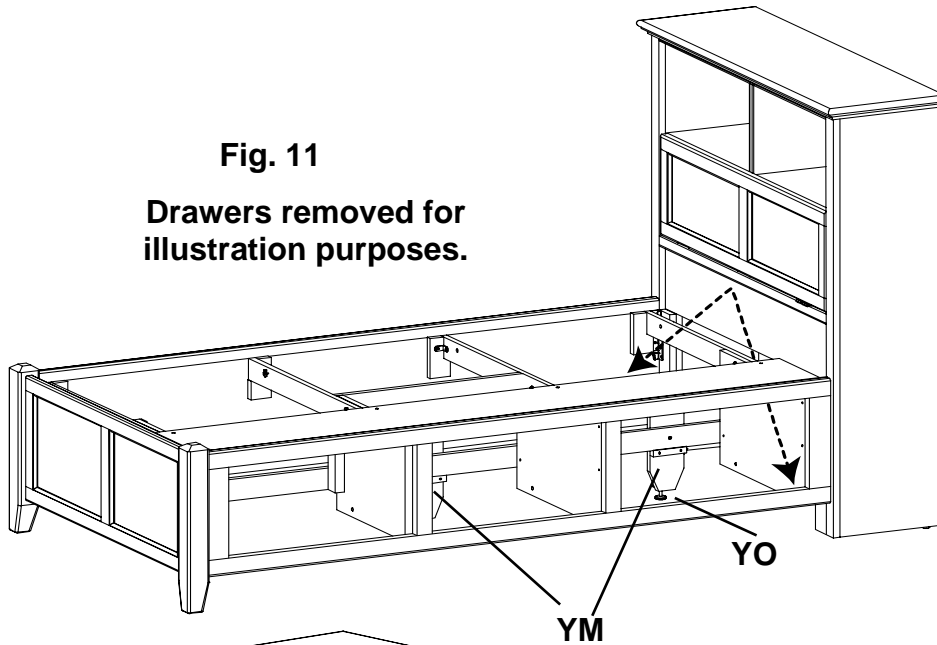

Fig. 11a

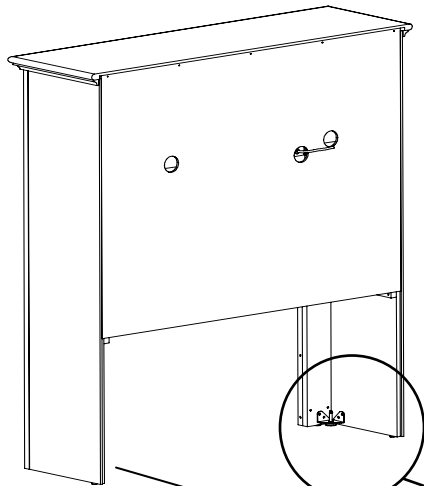
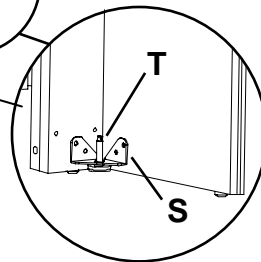

Fig. 11b



The top of the Large Adjustable Glide (T) is slotted.

**1300AFGACa; 1300AFCAFa McKenzie Twin Storage Bed;
1359AFGACc; 1359AFCAFc McKenzie Twin Bookcase Storage Bed**
Assembly Instructions

12. To make sure the bed is square, measure the distance between opposing corners. If one of the measurements is larger tap on a footboard leg until the measurement is equal. See Figure 12.

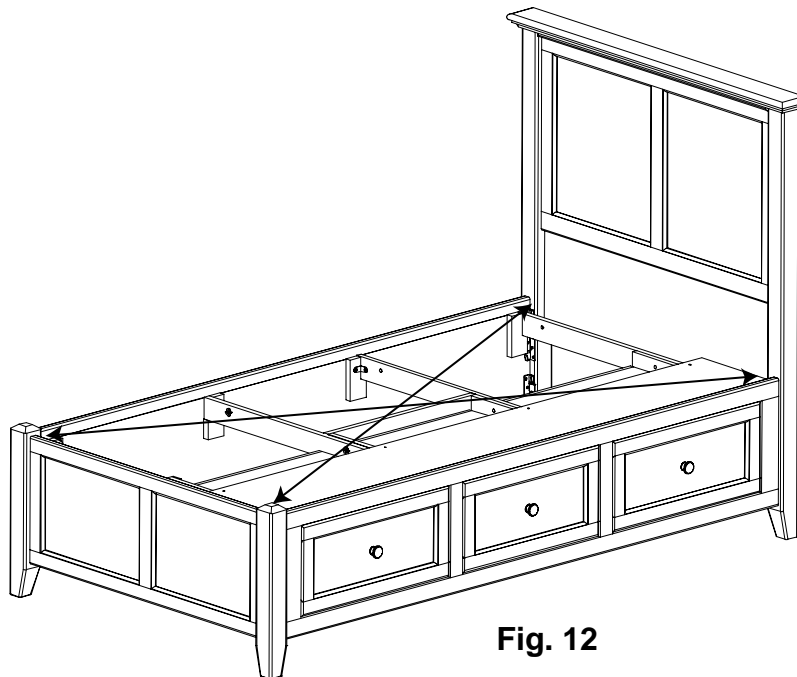

Fig. 12

13. Place the Center Deckboard (YJ) in the middle and with the notches facing out place the Notched Deckboard (YK) as shown in Figure 13. There should be a small gap between each deckboard. Secure with twenty #8 x 1-1/4" Black Screws (V).

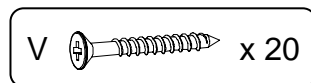
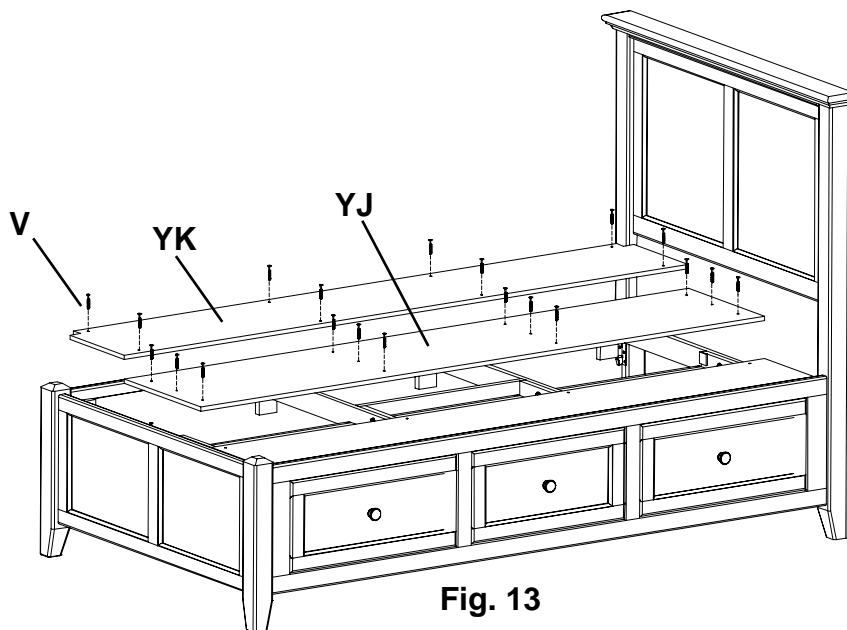

Fig. 13

**1300AFGACa; 1300AFCAFa McKenzie Twin Storage Bed;
1359AFGACc; 1359AFCAFc McKenzie Twin Bookcase Storage Bed**
Assembly Instructions

Steps 14 – 15 are for the Bookcase Headboard Only

14. To adjust the brake tension on the Door Stay (K) turn the screw on the Door Stay clockwise to loosen or counterclockwise to tighten. See Figures 14 and 14a.

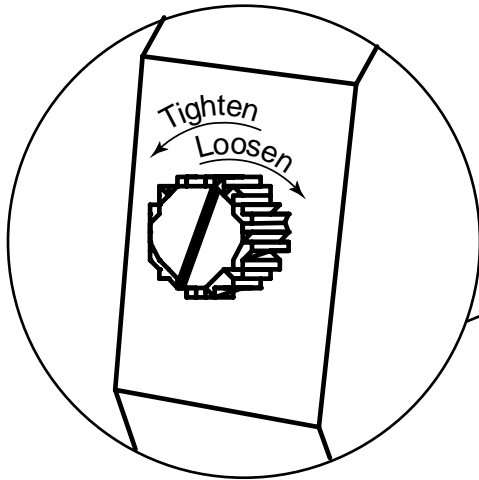

Fig. 14a

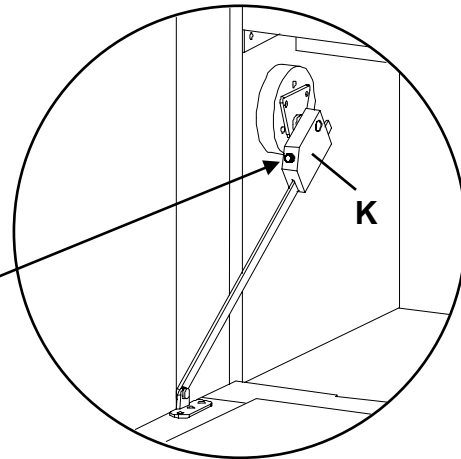

Fig. 14

15. Unwrap the False Bottoms (G) and place them on top of the rails in the Headboard Assembly (Ec). Make sure the finger holes face forward as shown in Figure 15. After you have placed your electronics inside the cubbies, use the Wire Clips (J) on the underside of the cubbies to secure the wires. Close the door tightly making sure the magnetic catches and plates securely touch.

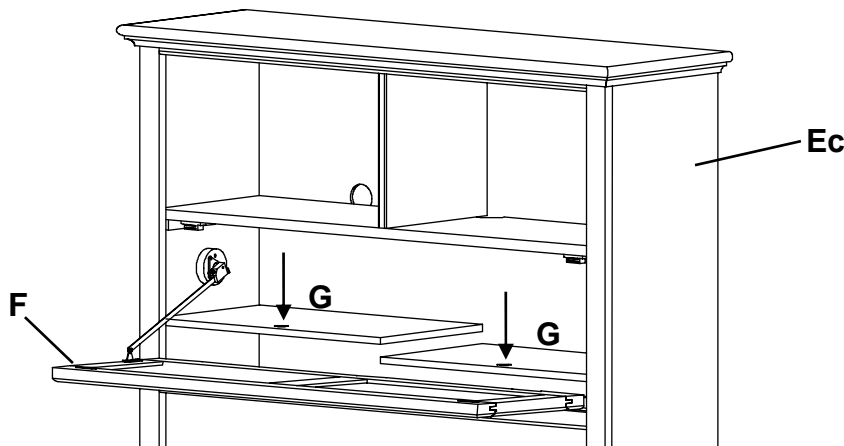

Fig. 15