

# 48" Wide McKenzie Alder Bookcases: 60" - 84"H Finished Program

Assembly Instructions

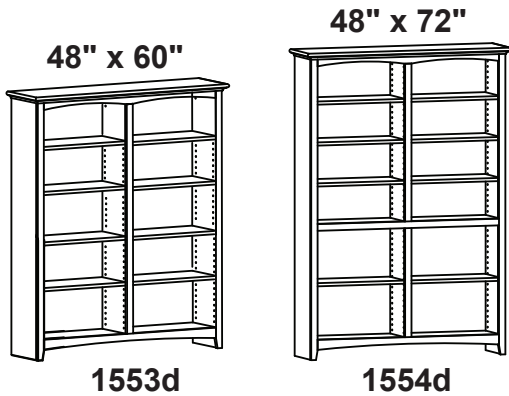

Model #

1553d

1554d

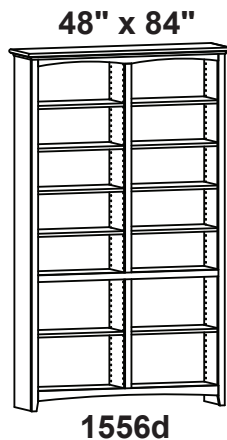

Model #

1556d

*Thank you for allowing us to help you furnish your home. We are certain you will be delighted with your new furniture for many years to come.*

## IMPORTANT NOTES:

- This assembly requires two people.
- For normal household use only. *Not* recommended for commercial use.
- Do not climb, sit or stand on this piece of furniture.
- Do not overload the shelves.
- Unload items before you move this unit.
- Before you load or move this unit, tighten all screws and supports.
- For maximum stability, attach unit to the wall using the enclosed hardware as per instructions and supports.
- Before you begin your project, completely read the Assembly Instructions.
- Periodically inspect your furniture for any loose glue joints, screws or any other problem that might affect the stability of your furniture. Tighten or repair as needed.

## WARNING

**Children have died from furniture tipover. To reduce the risk of furniture tipover:**

- ALWAYS install Anti-tip device provided.
- NEVER put a TV on this product.
- NEVER allow children to stand, climb or hang on doors, or shelves.
- Place heaviest items on the bottom shelves.

**Use of tipover restraints may only reduce, but not eliminate, the risk of tipover.**

**Attention:** Attached to the bottom of or included with this unit is a tipping restraint kit. When you receive your furniture, be sure to find and install the tipping restraint as instructed in the kit. If you cannot locate the restraint, please contact customer service immediately for a replacement.

Drilling, sawing, sanding or machining wood products can expose you to wood dust, a substance known to the state of California to cause cancer. Avoid inhaling wood dust or use a dust mask or other safeguards for personal protection.

For more information go to: [www.p65warnings.ca.gov/wood](http://www.p65warnings.ca.gov/wood)

This product can expose you to chemicals, including formaldehyde, which are known to the State of California to cause cancer. For more information go to: [www.p65warnings.ca.gov/furniture](http://www.p65warnings.ca.gov/furniture)

**DESIGN SUBJECT TO CHANGE WITHOUT NOTICE.**

## CUSTOMER SERVICE

If you ever have questions about your furniture, please do not hesitate to contact us. In the unlikely event you need a replacement part; we can make those parts available through an authorized Whittier Wood Furniture dealer. If you cannot order replacement parts through your dealer, please contact our customer service department.

**Hours:** Our friendly customer service staff can be reached:

**Monday-Friday 8:00 a.m. to 5:00 p.m. (Pacific Time).**

You may leave a message 24 hours a day, seven days a week.

**Customer Service:** 800-653-3336 • **Outside the U.S.:** 541-687-0213

**Fax:** 541-687-2060 • **Email:** [info@whittierwood.com](mailto:info@whittierwood.com)

**Whittier  
Wood**  
FURNITURE

P.O. Box 2827  
Eugene, OR 97402 USA

Production Code:

# McKenzie Alder Bookcase Program — Parts List

Before you begin to assemble this unit, identify each part and make sure the quantities received match what is on this list.

If you need to replace a part, please refer to the following list for the finish, part name and letter code.

## Bookcase Finish

Please note the finish of the bookcase for replacement part orders.

Bookcase finish options are subject to change.











### Stain

<b>GAC</b>	Glazed Antique Cherry	<b>JAV</b>	Java	<b>FST</b>	Fieldstone	<b>HAZ</b>	Hazelnut	<b>NA</b>	Natural Alder	<b>PEC</b>	Pecan
------------	--------------------------	------------	------	------------	------------	------------	----------	-----------	------------------	------------	-------

### Paint

<b>SN</b>	Snowbound SW 7004	<b>TB</b>	Tricorn Black SW 6258	<b>SNN</b>	Snowbound SW 7004 Natural Alder	<b>TBN</b>	Tricorn Black SW 6258 Natural Alder
-----------	----------------------	-----------	--------------------------	------------	---------------------------------------	------------	---

### Two-Tone

Part	Description	Image	Quantity (by Model #)		
			1553d	1554d	1556d
A	Adjustable Shelf (attached)		8	8	10
B	Shelf Bracket (inserted)		32	32	40
C	#6 x 1/2" Undercut Screw (inserted)		32	32	40
D	Top Assembly (attached)		1		
G	#8 x 1" Pan Head Screw (inserted)		10		
H	Nylon Insert (installed)		4		
J	#8 x 1-1/4" Pan Head Screw (inserted)		22	40	40
R	#8 x 1-5/8" Black Screw (inserted)		4		
TBa	Bookcase Tipping Restraint (attached)		1		
U	Slotted Leveler (inserted)		4		
Ua	Leveler Adjustment Key (Attached to Owner's Manual)		1		

# McKenzie Alder Bookcase

## Assembly Instructions

Tools Required: Phillips Screwdriver, Pencil, Rubber Mallet or Padded Hammer

Tools Provided: Leveler Adjustment Key in the Zip bag taped to the Owner's Manual and Safety Guide

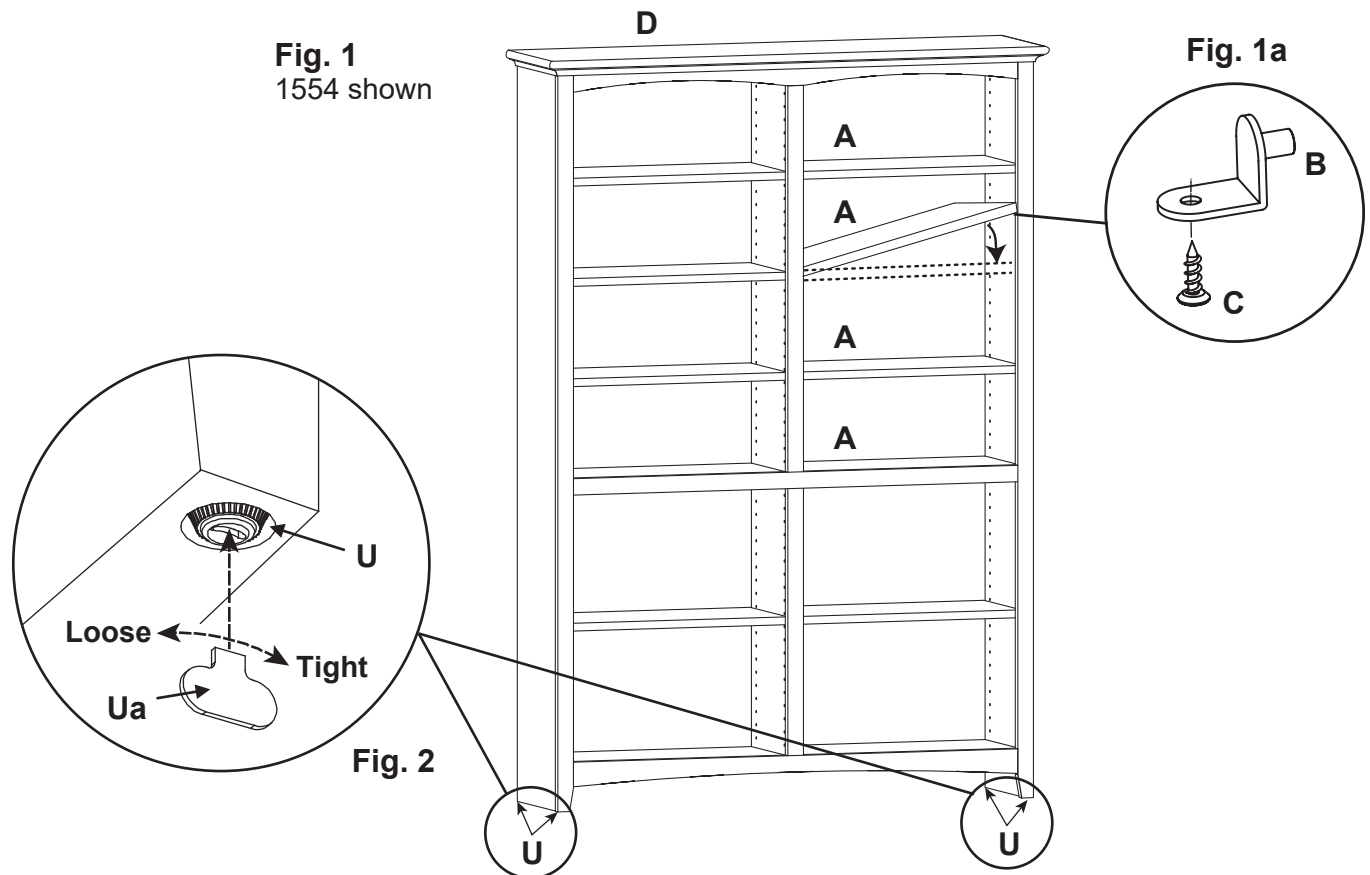

### To install the adjustable shelves. See Figure 1a:





1. Determine where you want to place the Adjustable Shelves (A). To support each shelf, tap the Shelf Brackets (B) into the four holes with the flat side down and install the shelf. You may secure the bracket to the shelf by inserting #6 x 1/2" Undercut Screws (C). Repeat for each shelf.
2. Place the bookcase at its final destination. Use the Leveler Adjustment Key (Ua), found in the Zip bag taped to the Owner's Manual and Safety Guide to rotate the Slotted Levelers (U) on the bottoms of the legs until the unit is level. See Figures 1 and 2.

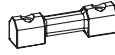

Continued on Page 4

# Bookcase Tipping Restraint Instructions

Before you begin this assembly, identify each part and make sure the quantities received match what is on this list. If you need to replace a part, contact Whittier Wood Furniture customer service and refer to the following list for its name and letter code.

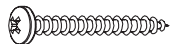
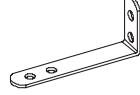
Part	Description		Quantity
A	Cam Buckle and Short Strap (installed)		1
B	Plastic Bracket (installed)		1
C	1" x 1000mm Long Strap (installed)		1
D	#8 x 3" Pan Head Screw		2
F	Washer (installed)		1
G	#8 x 5/8" Pan Head Screw		1
H	#8 x 1-1/4" Pan Head Screw		2 (1 inserted)
I	"L" Angle Bracket		1

**If you have a stone or tile floor or do not wish to drive screws into the corner of the baseboard and floor see the instruction included inside the tipping restraint kit for an alternate installation.**

- Decide where you want to place the bookcase in your room. Mark the baseboard with a pencil mark directly behind the location where the tipping restraint is attached to your item. Move the item away from the wall far enough to allow you to access the spot where the baseboard meets the floor. Position the straps and Plastic Bracket (B) as shown in Figures 3 and 3a with the angled corners of the Plastic Bracket (B) firmly placed against the seam of the baseboard and floor. Attach by driving #8 x 3" Pan Head Screws (D) through the holes in the Plastic Bracket (B) into the seam below the baseboard where it meets the floor. See Figures 3 and 3a.

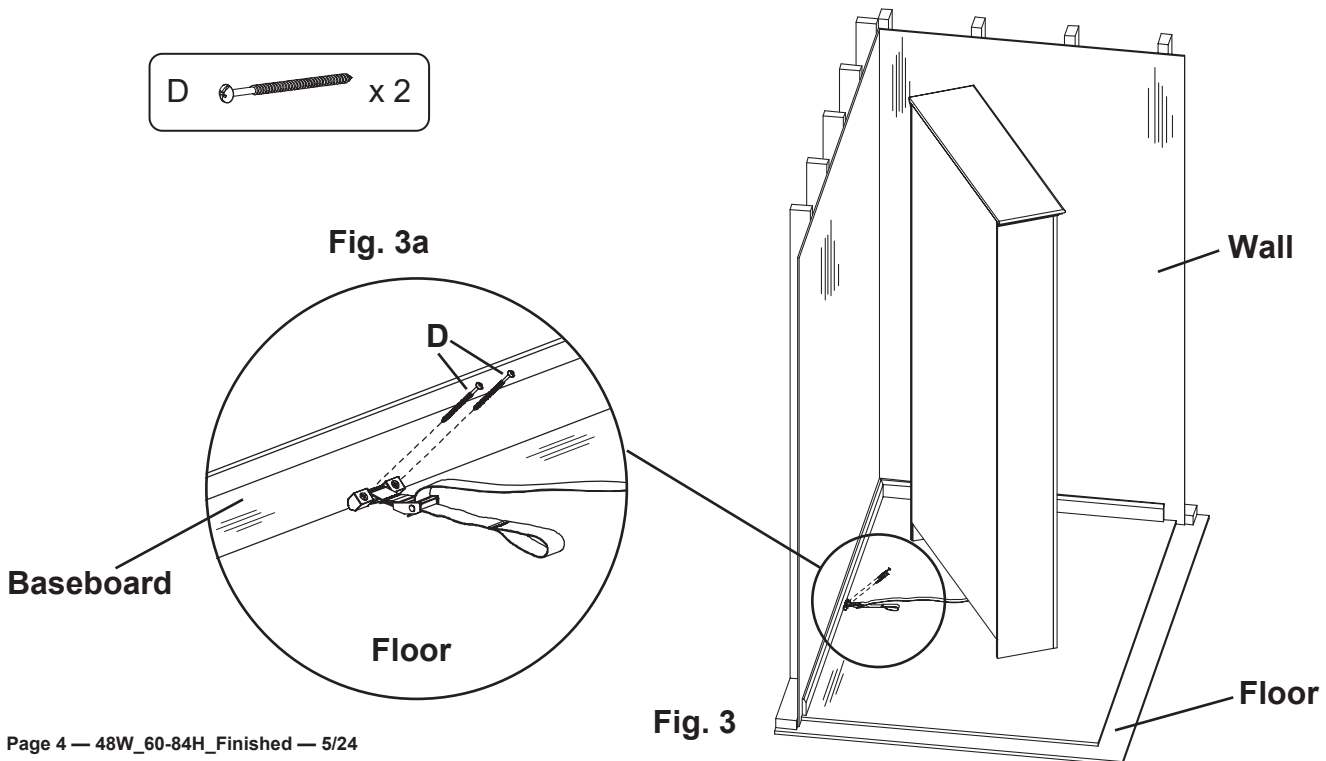

4. Move the item back into position against the wall and reach underneath the bookcase to grasp the loop in the free end of the strap. Pull the free end of the strap until portion between the Cam Buckle (A) and the bottom of the item is tight. See Figures 4 and 4a. If you need to move the bookcase reach beneath and locate the buckle which connects the two sections of the strap and depress the release lever, then pull on the section of strap that is between the buckle and the bottom of the furniture until there is enough slack to allow you to pull the item away from the wall.

